U.S. CATALOG

Softstarter

Type PSR, PSE and PSTX



—

Motors use almost one third of the world's generated electricity. So it is safe to say that reliable motor operation is crucial to our modern way of life.

Contents

04–14	ABB softstarter
15–24	PSR - The compact range
25–38	PSE - The efficient range
39–58	PSTX - The advanced range
59–61	Fieldbus communication
62–63	Marketing materials and tools

ABB softstarter

How we are helping the industry

A softstarter from ABB offers you several values and benefits. Whether you are a consultant, OEM, panel builder or end-user, a softstarter will add to your business value by securing motor reliability, improving installation efficiency and increasing application productivity.

SECURE MOTOR

Reliability



ABB softstarters help increase your motor's lifetime by protecting it from electrical stress. Starting currents are easily optimized to your load, application and motor size. Over ten motor protection features are included to keep your motor safe from different load and network irregularities.

IMPROVE INSTALLATION

Efficiency



Reduce your installation time and panel size by having all features you need built into your softstarter. Our softstarters are easy to install thanks to their compact design and many built-in features. The built-in bypass saves energy and space while reducing heat generation. A complete motor starting solution in one unit.

INCREASE APPLICATION

Productivity



Reduce the number of stops in your production by allowing your softstarter to do more than just starting. Our softstarters reduce the mechanical stress on your motor application, which will increase your uptime. Torque control, pump cleaning, motor brake and many other features enable you to operate your process at its full potential.



Xylem - South Africa

ABB's softstarters providing efficiency to the mining industry

One of Xylem's water solutions helps to prevent flooding in mines. Previous softstarters needed a lot of extra protection equipment. Xylem was looking for a simpler solution that would ensure reliability even at 3,500 meters depth. Reducing the number of components by 80 percent, shortened installation time by 60 percent. Costs cut to half has helped Xylem sell twice as many panels with softstarters as before.

Why softstarting matters to Xylem

Installation time reduced by

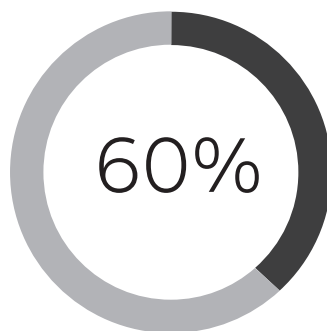

Total panel cost reduced by



ABB softstarter

How we are helping the industry

A softstarter can do wonders with your operations. Packed with useful features, it reduces the wear of your equipment, improve the reliability of your processes and increase overall productivity.

Controlling pumps

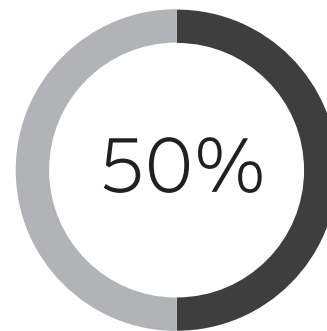
ELIMINATING WATER HAMMERING WITH TORQUE CONTROL

Water hammering is a common problem with pumps. It typically results in a lot on wear of pipes and valves when stopping the pump. The ABB softstarter feature torque control stop eliminates water hammering and prolongs the lifetime of the system, while reducing pump downtime.

KEEP PIPES AND PUMPS CLEAN

Many pumps risk getting clogged over time. This will cause reduced flow and increased risk of pump damage. Thanks to the feature to reverse the direction of the flow and start again with kick-start, ABB softstarters can help prevent and solve pump clogging and associated downtime.

AVOID RUNNING DRY WITH UNDERLOAD PROTECTION

Damages due to pumps running dry can be avoided with the softstarter feature underload protection. It stops the motor which saves the pump from additional wear and contributes to prolonging its lifetime.



Controlling fans

SOFT STARTING ADJUSTED TO APPLICATION

Fans normally have a high moment of inertia, which makes starting tough and current high. Using an ABB softstarter, the voltage is increased gradually during start, which reduces the current and removes the inrush peak. It is possible to adjust the settings to fit almost any starting condition, from unloaded to fully loaded.

FAST STOPS WITH MOTOR BRAKING

It can also take a long time to stop the fan. Active braking using the dynamic brake feature reduces stopping times. This improves process safety when the load has a high moment of inertia and makes fan operation easier for the operator.

AVOID UNWANTED MOVEMENTS WITH STAND STILL BRAKE

An idle fan that is rotating backwards, due to wind or airflow from another fan, can be kept still using the stand still brake. It prevents unwanted airflow and improves the control of the system without the need for an external mechanical brake.

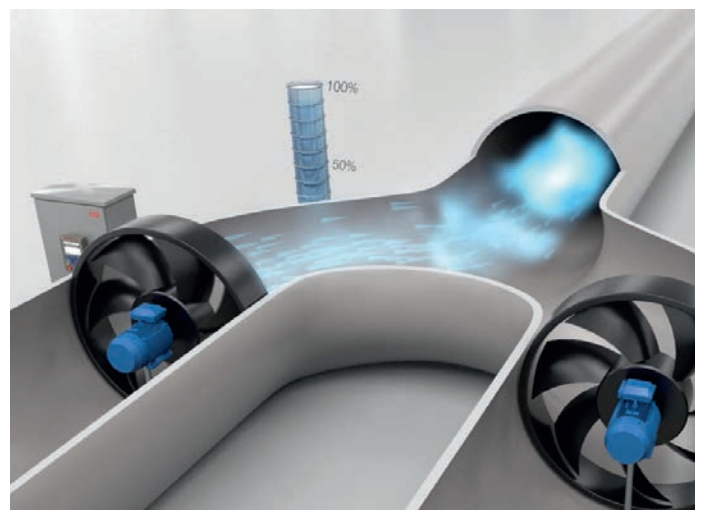

Controlling conveyor belts

AVOID OVERHEATING WITH OVERLOAD PROTECTION

Too much material on a conveyor belt may cause overload and overheating, reducing the reliability and longevity of the motor. ABB's overload protection feature shuts down the motor in case of overload, avoiding overheating.

INCREASED FLEXIBILITY WITH JOG WITH SLOW SPEED

After stopping the belt, it may be necessary to run the motor at low speed to correctly position the belt before resuming operation. The jog with slow speed feature makes it possible to position the belt manually, in both forward and reverse direction, before re-starting the belt. This improves process efficiency and eliminates the need for a variable speed drive, a considerably more expensive solution for solving the problem.

CONTINUOUS OPERATION WITH LIMP MODE

Shorted thyristor is a possible problem for a softstarter, putting it out of operation until the component has been replaced. Using limp mode, the softstarter will continue to work with one thyristor shorted, avoiding costly unplanned stoppages.



Controlling compressors

FULL CONTROL OF CURRENT WITH CURRENT LIMIT

Many applications are sensitive to high or variable starting currents. The feature current limit makes it possible to start the motor securely even in a weaker network, improving the availability of the equipment and system. Reducing the current means reducing the stress on cables, network and motor.

FULL VOLTAGE START FOR SCROLL COMPRESSORS

For scroll compressors it is often necessary to start the motor in a very short time while still maintaining a low starting current. Full voltage start is a start mode that gives you almost a direct start but without the current peak.

PHASE REVERSAL PROTECTION FOR PROBLEM-FREE COMMISSIONING

A motor rotating in the wrong direction, which may occur due to connecting the phases wrongly, may cause severe damage to a compressor. Using phase reversal protection, the motor won't start in the wrong direction, avoiding costly compressor downtime and repairs.



ABB softstarters

Why motor starting and stopping matters

There are some common issues associated with starting and stopping electrical motors. Depending on requirement, different starting and stopping methods can be used.

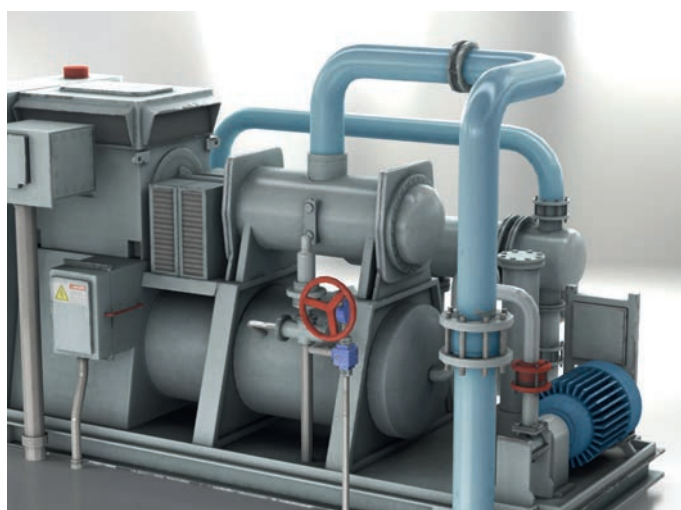

DIRECT-ON-LINE

Direct-on-line starting (DOL) is the easiest and most commonly used starting method. It is suitable for stable networks and mechanically stiff and well-dimensioned shaft systems due to the high current and torque generated during start.

DOL starting is uncontrolled, which means that the motor will start with maximum current and torque regardless of load type.



STAR-DELTA

A star-delta starter reduces current and torque during start. The starting current is about one third compared to direct-on-line starting, although it also reduces the starting torque to about 25 percent.

Star-delta is not adjustable, so if the torque is reduced too much, the motor will not start. Current peaks will happen when switching from star to delta connection.



SOFTSTARTER

Like direct-on-line and star delta starters, softstarters are used to start and stop motors in full-speed applications. It eliminates common problems associated with motor starting and stopping, including electrical surges, spikes and high inrush currents.

Because it offers soft starting and stopping, a softstarter is the optimal compromise between a direct-on-line or star-delta starter and a variable speed drive in many full-speed motor applications.

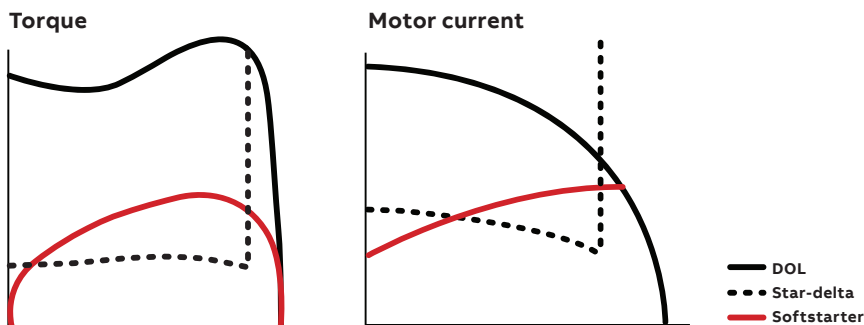

Typical torque and current curves from starting a motor using DOL, star-delta and softstarter.

VARIABLE SPEED DRIVE

Like a softstarter, a variable speed drive (VSD) can perform soft motor starting and stopping. However, the VSD was designed primarily to control motor speed, resulting in energy efficient motor operation in variable speed applications. Using a VSD with the sole purpose of ensuring soft starting and stopping of full-speed motors can therefore be considered an unnecessarily advanced solution.

ABB softstarters

A solution for every need

ABB's softstarter offering consists of three ranges, covering every need. The products help you secure motor reliability, improve installation efficiency and increase application productivity.



PSR – The compact range		PSE – The efficient range		PSTX – The advanced range	
Technical data:					
Rated motor current	3...105 A	Rated motor current	30...370 A	Rated motor current	30...1250 A (inside delta: 2160 A)
Main motor voltage	208...600 V	Main motor voltage	208...600 V	Main motor voltage	208...690 V
Control supply voltage	100...240 V AC or 24 V AC/DC	Control supply voltage	100...250 V AC	Control supply voltage	100...250 V AC

SOFTSTARTER FEATURE SELECTION GUIDE

	Current limit	Current limit ramp and dual current limit	Electronic motor overload protection	Dual overload protection	Underload protection	Power factor protection	Locked rotor underload protection	Current/Voltage protection	Phase reversal/imbalance protection	Customer defined protection	Motor heating	PTC/PT100 input for motor protection	Overvoltage/undervoltage protection	Earth-fault protection	Built-in bypass	Inside-delta connection protection	Graphical display and keypad	Detachable keypad	Motor runtime and start count	Programmable warning functions	Diagnostics	Overload time-to-trip	Overload time-to-cool	Analog output	Fieldbus communication	Event log	Multiple languages	Electricity metering	Torque control	Torque limit	Coated PCBs	Limp mode	Jog with slow speed forward/reverse	Dynamic brake	Stand still brake	Sequence start	Full voltage start	Kick start	Automatic pump cleaning		
PSR	—	—	—	—	—	—	—	—	—	—	—	—	—	—	—	—	—	—	—	—	—	—	—	—	—	—	—	—	—	—	—	—	—	—	—	—	—	—	—	—	
PSE	•	—	•	—	•	—	•	—	—	—	—	—	—	—	—	—	—	—	—	—	—	—	—	—	—	—	—	—	—	—	—	—	—	—	—	—	—	—	—	—	
PSTX	•	•	•	•	•	•	•	•	•	•	•	•	•	•	•	•	•	•	•	•	•	•	•	•	•	•	•	•	•	•	•	•	•	•	•	•	•	•	•	•	•
	Secure motor reliability											Improve installation efficiency											Increase application productivity																		

• Standard ◦ Optional — Not available

ABB softstarters

A part of your motor starting solution

Motor starting requires several components to work perfectly together. ABB is a one-stop shop for motor starting, offering all the necessary components and complete motor starting solutions, proven together in numerous installations worldwide.



Can I use a Softstarter for an ATEX motor?

ABB's softstarters PSR, PSE and PSTX can be used to start ATEX classified motors in Ex environments if the following considerations are taken into account:

- The softstarter has to be placed outside the Ex area. Either in another location or inside an ATEX approved panel.
- A separate ATEX approved overload relay from ABB has to be used together with a line contactor. This overload relay will replace the built-in EOL in the softstarter and has an ATEX approved tripping curve.
- Select softstarter according to normal or heavy-duty start depending on application and line contactor and overload relay with type 2 coordination.



Can I use a softstarter on a ship?

ABB's softstarters PSE and PSTX have marine approvals and are certified for marine environment.

Ships uses IT-networks which means that there is a floating electrical ground. It is possible to use an ABB softstarter in such a network but it is recommended to not connect the functional ground on the softstarter to the ship to avoid disturbances from the network to effect the electronics inside the softstarter.

ABB softstarters

Wall mounting instructions

Minimum distance to wall mm (in)

Softstarter, type	A ¹⁾	B ¹⁾	C	D
PSR				
PSR3 ... PSR16	0	0	25 (0.98)	N/A
PSR25 ... PSR30	0	0	25 (0.98)	N/A
PSR37 ... PSR45	0	0	25 (0.98)	N/A
PSR60 ... PSR105	0	0	25 (0.98)	N/A
PSE				
PSE18 ... PSE105	100 (3.94)	10 (0.39)	20 (0.79)	N/A
PSE142 ... PSE170	100 (3.94)	10 (0.39)	20 (0.79)	N/A
PSE210 ... PSE370	100 (3.94)	10 (0.39)	20 (0.79)	N/A
PSTX				
PSTX30 ... PSTX105	100 (3.94)	10 (0.39)	20 (0.79)	35 (1.38)
PSTX142 ... PSTX170	100 (3.94)	10 (0.39)	20 (0.79)	35 (1.38)
PSTX210 ... PSTX370	100 (3.94)	10 (0.39)	20 (0.79)	35 (1.38)
PSTX470 ... PSTX570	150 (5.91)	15 (0.59)	20 (0.79)	35 (1.38)
PSTX720 ... PSTX840	150 (5.91)	15 (0.59)	20 (0.79)	35 (1.38)
PSTX1050 ... PSTX1250	150 (5.91)	15 (0.59)	20 (0.79)	35 (1.38)

¹⁾ PSR, Only for wall mounted Softstarters

Minimum distance to front

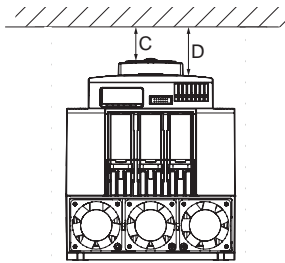

Minimum distance to wall

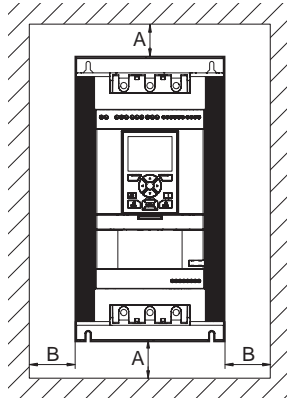

Maximum mounting angle

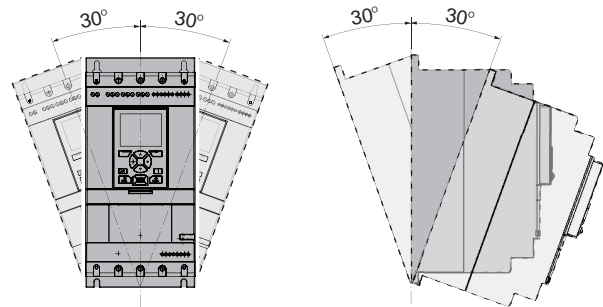

Items included in the box with the softstarter







	Multi-language manual	Terminal kit	Cable and mounting kit for detachable keypad
PSR3 ... PSR105	•	—	—
PSE18 ... PSE370	•	•	—
PSTX30 ... PSTX1250	•	•	•

ABB softstarters

Certifications and approvals

The table below shows the certifications and approvals for ABB's softstarters. For other certifications and/or approvals, please contact ABB.

Certifications and approvals

Abbreviation approved in	Certifications						Approvals: ship classification societies					
							ABS	DNV GL	Lloyd's Register	CCS	PRS	Class NK
PSR3 ... PSR105	•	•	•	•	•	•	—	—	—	—	•	—
PSE18 ... PSE370	•	•	•	•	•	•	•	•	•	•	•	•
PSTX30 ... PSTX1250	•	•	•	•	•	•	•	•	•	•	•	•

Note: • Standard design approved, the products bear the certification mark when it is required.

Directives and standards

No. 2006/95/EC	Low voltage equipment
No. 2004/108/EC	Electromagnetic compatibility
EN 60947-1	Low-voltage switchgear and controlgear - Part 1: General rules
EN 60947-4-2	AC semiconductor motor controllers and starters
UL 508	Industrial Control Equipment
CSA C22.2 No 14	Industrial Control Equipment

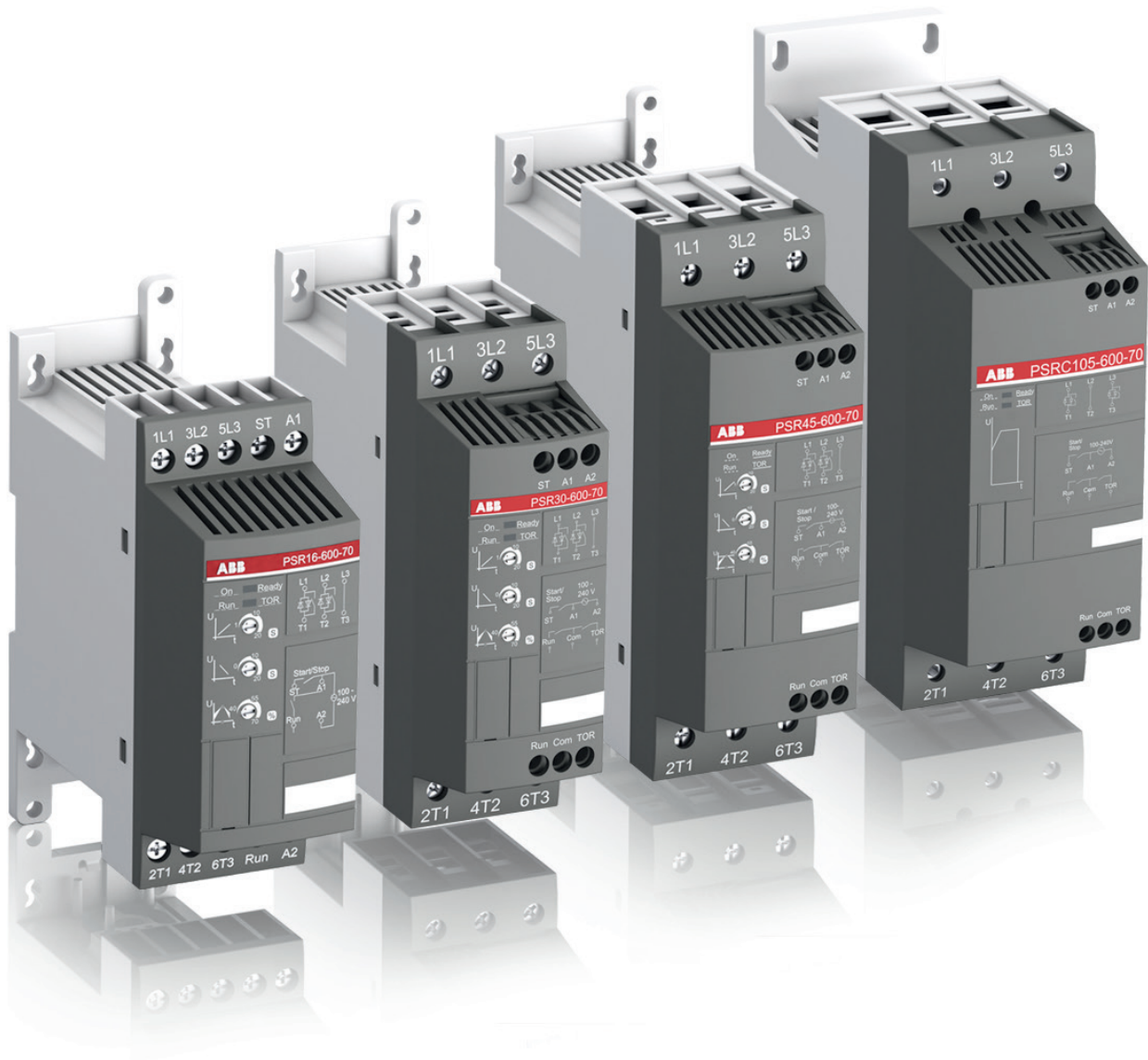

The PSR softstarter is the most compact of all the softstarter ranges which allows for design of a compact starting equipment. The PSR combined with a manual motor starter makes up a far more compact starting solution than the complex star-delta starter, and with the built-in bypass, the energy losses inside the softstarter are highly reduced.

PSR - The compact range

16–17	PSR - The compact range
18	Overview
19	Ordering details
20	Accessories
21	Technical data
22	Dimensions
23	Circuit diagrams

PSR - The compact range

Introduction



- Two-phase controlled
- Operational voltage: 208...600 V AC
- Wide rated control supply voltage: 100...240 V AC, 50/60 Hz or 24 V AC/DC
- Rated operational current: 3...105 A
- Soft start with voltage ramp
- Soft stop with voltage ramp
- Built-in bypass for energy saving and easy installation
- Easy set-up by three potentiometers
- Fieldbus communication with FieldBusPlugadapter and the FieldBusPlug
- Run and Top of Ramp relays available for monitoring
- Connection kits available for connection to ABB's manual motor starters (MMS)

SECURE MOTOR

Reliability



REDUCE THE ELECTRICAL STRESSES AND KEEP THE MOTOR PROTECTED WITH THE MMS

The PSR reduces the starting current for the motor. The possibility to connect it to the manual motor starter makes it possible to build a compact and complete starting solution with overload and short-circuit protection.

IMPROVE INSTALLATION

Efficiency



SAVING TIME AND MONEY WITH BUILT-IN BYPASS AND EASY SET-UP

On the PSR, the bypass is built in and verified by ABB, saving you time during installation and space in your panel. Set-up is done through three potentiometers making it very fast and easy.

INCREASE APPLICATION

Productivity



REDUCE THE MECHANICAL STRESSES ON YOUR MOTOR

Soft start and stop with PSR will reduce mechanical wear and tear on the application and increase the availability and uptime.

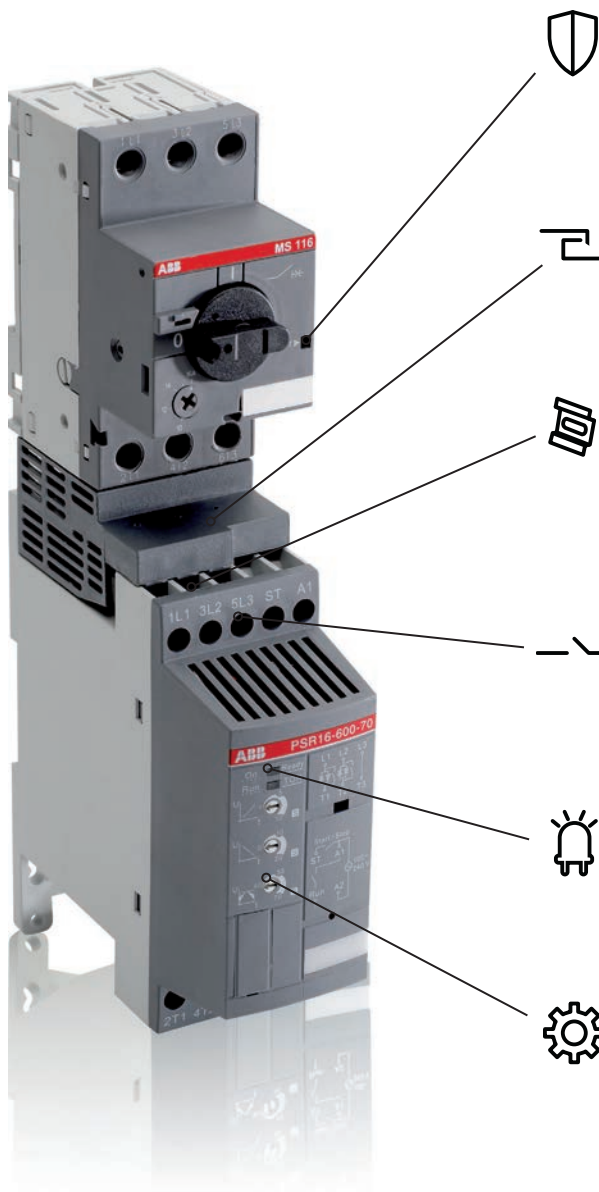

MOTOR PROTECTION WITH MANUAL MOTOR STARTER
Use the PSR together with the MMS to get a complete motor starter with soft start and stop together with overload and short circuit protection.



CONNECTION KIT (OPTIONAL)
The connection kits simplifies installation of the PSR by making the connection to the MMS screwless.



SCREW OR DIN-RAIL MOUNTED
PSR is fast and easy to install by using screw mounting or DIN-rail mounting (PSR3 ... PSR45).



OUTPUT SIGNAL RELAYS
PSR has output relays for Run and Top of ramp (PSR25 ... PSR105).



LED INDICATORS
PSR has LED indicators for On/Ready and Run/Top of ramp.



THREE POTENTIOMETERS FOR SETTINGS
Set-up is made very easy with only three potentiometers, for start ramp time, stop ramp time and initial/end voltage level.

SETTINGS

- 1 Start = 1...20 sec
 - 2 Stop = 0...20 sec - including the step down voltage
 - 3 Step down = 2% reduction for each second increased stop ramp
- $U_{ini} = 40...70\%$ results in end voltage = 30...60%

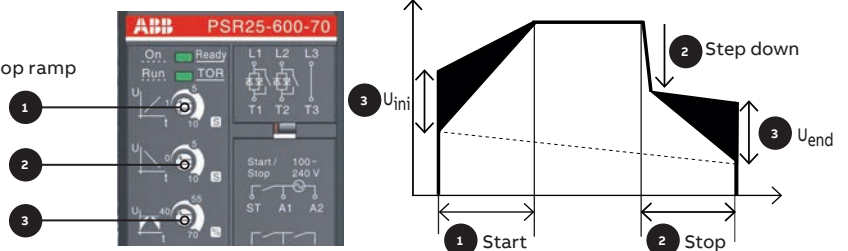

PSR - The compact range

Overview



PSR3 ... PSR16



PSR25 ... PSR30



PSR37 ... PSR45



PSR60 ... PSR105

Normal start In-line connected (400 V) kW IEC, max. A (440-480 V) hp UL, max. FLA	PSR3	PSR6	PSR9	PSR12	PSR16	PSR25	PSR30	PSR37	PSR45	PSR60	PSR72	PSR85	PSR105
	1.5	3	4	5.5	7.5	11	15	18.5	22	30	37	45	55
	3.9	6.8	9	12	16	25	30	37	45	60	72	85	105
	2	3	5	7.5	10	15	20	25	30	40	50	60	75
	3.4	6.1	9	11	15.2	24.2	28	34	46.2	59.4	68	80	104

400 V, 40 °C

Using manual motor starters type 1 coordination will be achieved ¹⁾

Manual motor starter (50 kA)

MS116	MS132	MS450	MS495	—
-------	-------	-------	-------	---

Using gG fuses type 1 coordination will be achieved ¹⁾

Fuse protection (50 kA) gG Fuse

10 A	16 A	25 A	32 A	50 A	63 A	100 A	125 A	200 A	250 A
------	------	------	------	------	------	-------	-------	-------	-------

Suitable switch fuse for the above gG fuses ¹⁾

Switch fuse

OS32G			OS125G			OS250		
-------	--	--	--------	--	--	-------	--	--

J-type fuses for UL coordination ¹⁾

Max. fuse, J-type

35 A			60 A			90 A			110 A			125 A			150 A			200 A		
------	--	--	------	--	--	------	--	--	-------	--	--	-------	--	--	-------	--	--	-------	--	--

Overload protection is used to protect the motor from over heating ¹⁾

Thermal overload relay

TF42DU						TA75DU			TA110DU		
--------	--	--	--	--	--	--------	--	--	---------	--	--

The line contactor is not required for the softstarter itself but often used to open if OL trips ¹⁾

Line contactor

AF9	AF12	AF16	AF26	AF30	AF38	AF52	AF65	AF80	AF96	AF116
-----	------	------	------	------	------	------	------	------	------	-------

¹⁾ This is an example of coordination.



PSR - The compact range

Ordering details

Typical applications

- Bow thruster
- Centrifugal pump
- Compressor
- Conveyor belt (short)
- Elevator



PSR3 ... PSR16



PSR25 ... PSR30



PSR37 ... PSR45



PSR60 ... PSR105

Rated operational voltage U_e , 208...600 V AC

Rated control supply voltage, U_s , 100...240 V AC, 50/60 Hz

IEC				UL/CSA				Type	Order code	Weight pkg (1 pce)		
Rated operational power		current	Rated operational power	current				FLA			kg	(lb)
230 V	400 V	500 V		200/208 V	220/240 V	440/480 V	550/600 V					
P_e	P_e	P_e	I_e	P_e	P_e	P_e	P_e					
kW	kW	kW	A	hp	hp	hp	hp	A				
0.75	1.5	2.2	3.9	0.5	0.75	2	2	3.4	PSR3-600-70	1SFA896103R7000	0.45 (0.99)	
1.5	3	4	6.8	1	1.5	3	5	6.1	PSR6-600-70	1SFA896104R7000	0.45 (0.99)	
2.2	4	4	9	2	2	5	7.5	9	PSR9-600-70	1SFA896105R7000	0.45 (0.99)	
3	5.5	5.5	12	3	3	7.5	10	11	PSR12-600-70	1SFA896106R7000	0.45 (0.99)	
4	7.5	7.5	16	3	5	10	10	15.2	PSR16-600-70	1SFA896107R7000	0.45 (0.99)	
5.5	11	15	25	7.5	7.5	15	20	24.2	PSR25-600-70	1SFA896108R7000	0.65 (1.43)	
7.5	15	18.5	30	7.5	10	20	25	28	PSR30-600-70	1SFA896109R7000	0.65 (1.43)	
7.5	18.5	22	37	10	10	25	30	34	PSR37-600-70	1SFA896110R7000	1.00 (2.20)	
11	22	30	45	15	15	30	40	46.2	PSR45-600-70	1SFA896111R7000	1.00 (2.20)	
15	30	37	60	20	20	40	50	59.4	PSR60-600-70	1SFA896112R7000	2.20 (4.85)	
22	37	45	72	20	25	50	60	68	PSR72-600-70	1SFA896113R7000	2.27 (5.00)	
22	45	55	85	25	30	60	75	80	PSR85-600-70	1SFA896114R7000	2.27 (5.00)	
30	55	55	105	30	40	75	100	104	PSR105-600-70	1SFA896115R7000	2.27 (5.00)	









Rated operational voltage U_e , 208...600 V AC

Rated control supply voltage, U_s , 24 V AC/DC, 50/60 Hz

0.75	1.5	2.2	3.9	0.5	0.75	2	2	3.4	PSR3-600-11	1SFA896103R1100	0.45 (0.99)
1.5	3	4	6.8	1	1.5	3	5	6.1	PSR6-600-11	1SFA896104R1100	0.45 (0.99)
2.2	4	4	9	2	2	5	7.5	9	PSR9-600-11	1SFA896105R1100	0.45 (0.99)
3	5.5	5.5	12	3	3	7.5	10	11	PSR12-600-11	1SFA896106R1100	0.45 (0.99)
4	7.5	7.5	16	3	5	10	10	15.2	PSR16-600-11	1SFA896107R1100	0.45 (0.99)
5.5	11	15	25	7.5	7.5	15	20	24.2	PSR25-600-11	1SFA896108R1100	0.65 (1.43)
7.5	15	18.5	30	7.5	10	20	25	28	PSR30-600-11	1SFA896109R1100	0.65 (1.43)
7.5	18.5	22	37	10	10	25	30	34	PSR37-600-11	1SFA896110R1100	1.00 (2.20)
11	22	30	45	15	15	30	40	46.2	PSR45-600-11	1SFA896111R1100	1.00 (2.20)
15	30	37	60	20	20	40	50	59.4	PSR60-600-11	1SFA896112R1100	2.20 (4.85)
22	37	45	72	20	25	50	60	68	PSR72-600-11	1SFA896113R1100	2.27 (5.00)
22	45	55	85	25	30	60	75	80	PSR85-600-11	1SFA896114R1100	2.27 (5.00)
30	55	55	105	30	40	75	100	104	PSR105-600-11	1SFA896115R1100	2.27 (5.00)

PSR - The compact range

Accessories

 PSR16-MS116  PSR30-MS132  PSR45-MS165  PSR60-MS165  PSR105-MS495	For softstarter type	Type	Order code	Pkg qty	Weight (1 pce)	(lb)	
	Connection kit						
		PSR3...16	PSR16-MS116	1SFA896211R1001	1	0.022	(0.049)
		PSR25...30	PSR30-MS132	1SFA896212R1001	1	0.040	(0.088)
		PSR60...105	PSR105-MS495	1SAM501903R1001	1	0.034	(0.075)
		PSR37...45	PSR45-MS165	1SFA896216R1001	1	0.050	(0.110)
	PSR60...72	PSR60-MS165	1SFA896215R1001	1	0.050	(0.110)	
 PSR-FAN3-45A  PSR-FAN60-105A	For softstarter type	Type	Order code	Pkg qty	Weight (1 pce)	(lb)	
	Fan						
		PSR3 ... PSR45	PSR-FAN3-45A	1SFA896311R1001	1	0.010	(0.022)
	PSR60 ... PSR105	PSR-FAN60-105A	1SFA896313R1001	1	0.013	(0.029)	
 PSLW	For softstarter type	Type	Order code	Pkg qty	Weight (1 pce)	(lb)	
	Terminal enlargements						
	PSR60 ... PSR105 Wire range mm ² 1 x 10...50 mm ² , 2 x 10...25 mm ²	PSLW-72	1SFA899002R1072	1	0.150	(0.033)	

PSR - The compact range

Technical data

Softstarter types	PSR3	PSR6	PSR9	PSR12	PSR16	PSR25	PSR30	PSR37	PSR45	PSR60	PSR72	PSR85	PSR105	
Rated insulation voltage U_i	600 V													
Rated operational voltage U_e	208...600 V +10%/-15%, 50/60 Hz ±5%													
Rated control supply voltage U_s	100...240 V AC, 50/60Hz ±5% or 24 V AC/DC, +10%/-15%,													
Starting capacity at I_e	4 x I _e for 6 sec.													
Number of starts per hour	See table below for details													
standard	10 ¹⁾													
with aux. fan	20 ¹⁾													
Ambient temperature														
during operation	-25...+60 °C (-13...+140 F) ²⁾													
during storage	-40...+70 °C (-40...+158 F)													
Maximum altitude	4000 m (13123 ft) ³⁾													
Degree of protection														
main circuit	IP20								IP10					
control circuit	IP20													
Power consumption: Supply circuit														
at 100...240 V AC	12 VA								10 VA					
at 24 V AC/DC	5 W													
Max. Power loss at rated I_e	0.7 W	2.9 W	6.5 W	11.5 W	20.5 W	25 W	36 W	5.5 W	8.1 W	3.6 W	5.2 W	7.2 W	6.6 W	
Connectable cable area														
main circuit	1 x 0.75...2.5 mm ² (19...14 AWG)				1 x 2.5...10 mm ² (14...8 AWG)			1 x 6...35 mm ² (10...2 AWG)		1 x 10...95 mm ² (8...4/0 AWG)				
control circuit	2 x 0.75...2.5 mm ² (19...14 AWG)				2 x 2.5...10 mm ² (14...8 AWG)			2 x 6...16 mm ² (10...6 AWG)		2 x 6...35 mm ² (10...2 AWG)				
main circuit	1 x 0.75...2.5 mm ² (19...14 AWG)				1 x 0.75...2.5 mm ² (19...14 AWG)			2 x 0.75...1.5 mm ² (19...16 AWG)						
control circuit	2 x 0.75...2.5 mm ² (19...14 AWG)				2 x 0.75...1.5 mm ² (19...16 AWG)									
Signal relays														
for run signal resistive load AC-15 (contactor)	3 A 0.5 A				3 A 0.5 A									
for top of ramp signal resistive load AC-15 (contactor)	- -				3 A 0.5 A									
LED														
for On/Ready	Green													
for Run/Top of ramp	Green													
Settings														
Ramp time during start	1...20 sec.													
Ramp time during stop	0...20 sec.													
Initial- and end voltage	40...70%													

¹⁾ Valid for 50% on time and 50% off time. If other data is required, contact your local ABB office.

²⁾ Above 40 °C (104 F) up to max. 60 °C (140 F) reduce the rated current with 0.8% per °C (0.44% per F).

³⁾ When used at high altitudes, above 1000 meters (3281 ft) up to 4000 meters (13123 ft), de-rate the rated current using the following formula.

$$\left[\% \text{ of } I_e = 100 - \frac{x-1000}{150} \right] \quad x = \text{actual altitude of the softstarter in meter.}$$

Number of starts per hour using PSR softstarters

Motor current I _e	Starts/hour without auxiliary fan								Starts/hour with auxiliary fan							
	10	20	30	40	50	60	80	100	10	20	30	40	50	60	80	100
3 A	PSR3								PSR3							
6 A	PSR6				PSR9				PSR6				PSR9			
9 A	PSR9		PSR12		PSR16		PSR25		PSR9		PSR12		PSR16		PSR25	
12 A	PSR12		PSR16		PSR25		PSR30		PSR12		PSR16		PSR25		PSR30	
16 A	PSR16		PSR25		PSR30		PSR37		PSR16		PSR25		PSR30		PSR37	
25 A	PSR25		PSR30		PSR37		PSR45		PSR25		PSR30		PSR37		PSR45	
30 A	PSR30		PSR37		PSR45		PSR60		PSR30		PSR37		PSR45			
37 A	PSR37		PSR45		PSR60		PSR72		PSR37		PSR45		PSR60			
45 A	PSR45		PSR60		PSR72		PSR85		PSR45		PSR60		PSR72			
60 A	PSR60		PSR72		PSR85		PSR105		PSR60		PSR72		PSR85		PSR105	
72 A	PSR72		PSR85		PSR105		-		PSR72		PSR85		PSR105		-	
85 A	PSR85		PSR105		-		-		PSR85		PSR105		-		-	
105 A	PSR105		-		-		-		PSR105		-		-		-	

Data based on an ambient temperature of 40° (104 F), starting current of 4 x I_e and ramp time 6 seconds.

For more optimized selection or to use PSR for heavy-duty starts, please use the softstarter selection tool.

PSR - The compact range

Dimensions

Main dimensions mm, inches

PSR3 ... PSR16

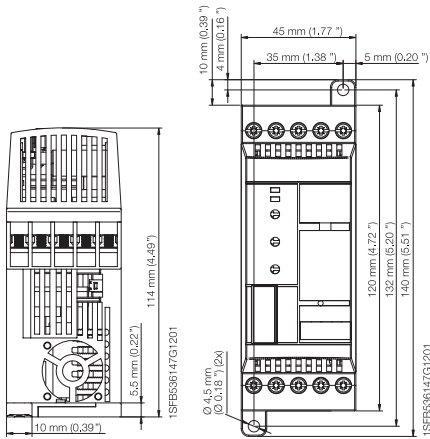

PSR25 ... PSR30

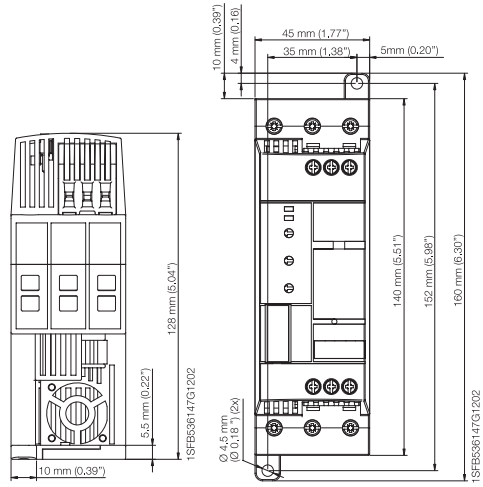

PSR37 ... PSR45

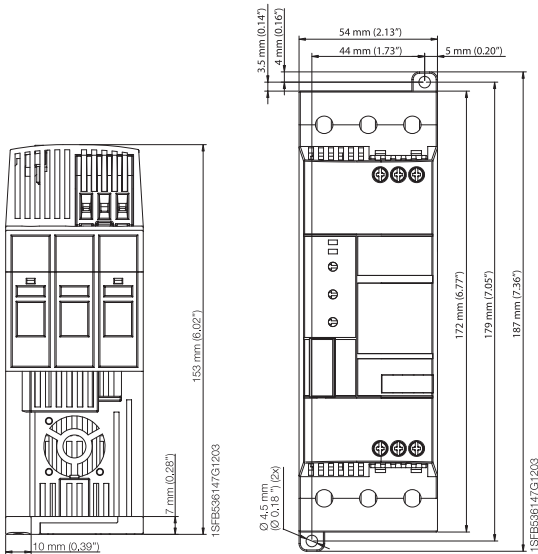

PSR60 ... PSR105

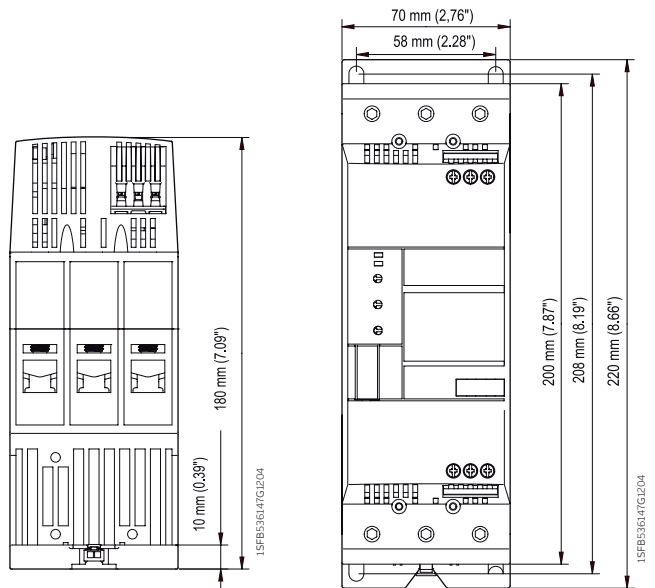

PSR - The compact range

Circuit diagrams

Main dimensions mm, inches

PSR3 ... PSR16 With MMS

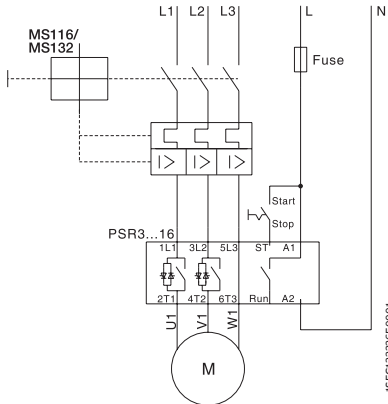

With MMS and auxiliary contact

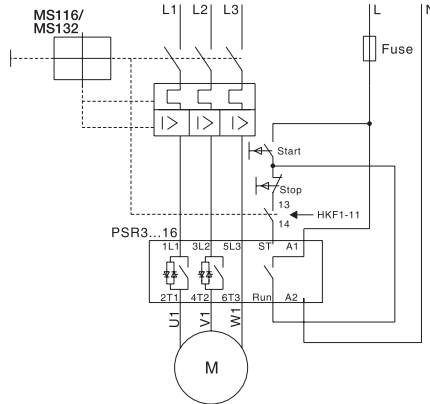

With fuses, contactor and O.L.

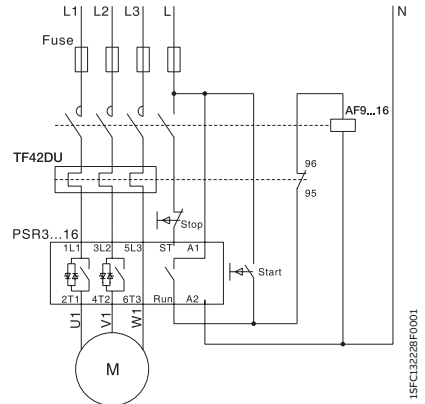

PSR25 ... PSR45 With MMS

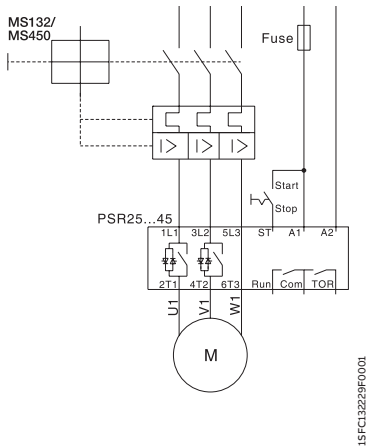

With MMS and auxiliary contact

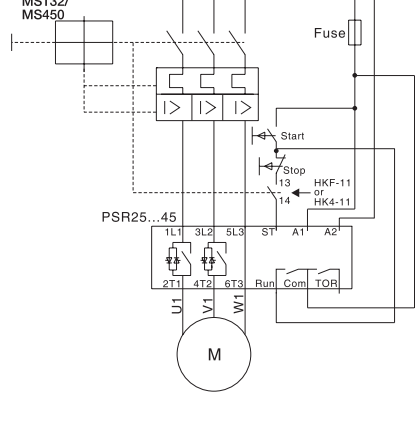

With fuses, contactor and O.L.

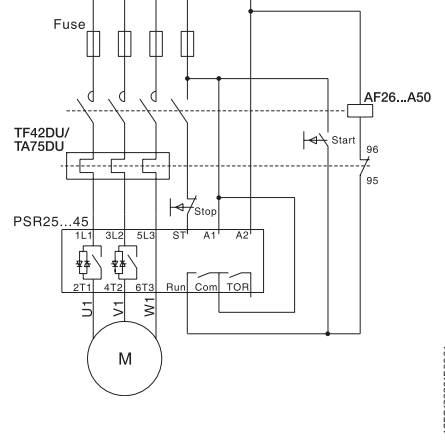

PSR60 ... PSR105 With MMS

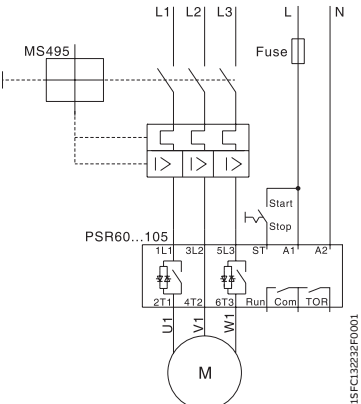

With MMS and auxiliary contact

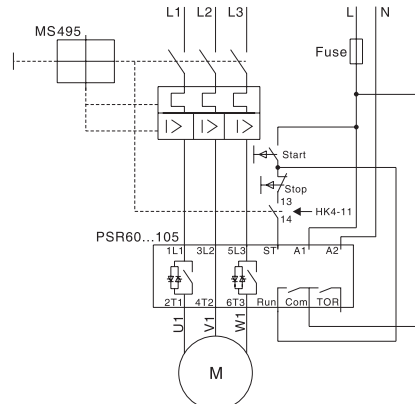

With fuses, contactor and O.L.

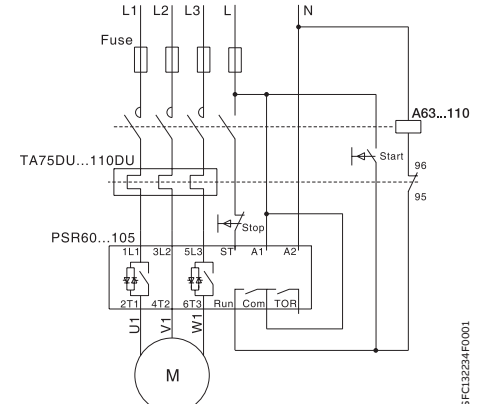



The PSE has been designed to meet the most common requirements from the water segment and is specialized on pump operation. It combines the requested protections with a very compact design and built-in bypass. Remote operation with external keypad or over fieldbus is available as an option.

PSE - The efficient range

26–27	Introduction
28–29	Overview
30–31	ordering details
32	Accessories
33–35	Technical data
36	Dimensions
37	Circuit diagrams

PSE - The efficient range

Introduction



- Two-phase controlled
- Operational voltage: 208...600 V AC
- Wide rated control supply voltage: 100...250 V AC, 50/60 Hz
- Rated operational current: 18...370 A
- Voltage ramp and torque control for both start and stop
- Current limit
- Kick-start
- Built-in bypass for energy saving and easy installation
- Coated PCBA protecting from dust, moist and corrosive atmosphere
- Illuminated display that uses symbols to become language neutral
- External keypad rated IP66 (Type 1, 4X,12) as an option
- Fieldbus communication with FieldBusPlug adapter and the FieldBusPlug
- Analog output for display of motor current
- Electronic overload protection
- Underload protection
- Locked rotor protection

SECURE MOTOR

Reliability



BASIC MOTOR PROTECTION AND CURRENT LIMIT

The PSE includes the most important protections for handling different load situations that can happen to pumps e.g. overload and underload. The current limit gives you more control of the motor during start and allows you to start your motor in weaker networks.

IMPROVE INSTALLATION

Efficiency



SAVING TIME AND MONEY WITH BUILT-IN BYPASS AND COMPACT DESIGN

On the PSE, the bypass is built in and verified by ABB, saving you time during installation and space in your panel. The keypad is language neutral and illuminated for easy set-up and operation in field. The compact design makes installation fast and easy.

INCREASE APPLICATION

Productivity



TORQUE CONTROL FOR ELIMINATION OF WATER HAMMERING IN PUMPS

Torque control is the most efficient way to stop a full speed pump. The PSE has a special torque stop ramp that is designed together with a pump manufacturer to eliminate water hammering in an optimal way.



SCREW MOUNTING

PSE is fast easy to install by using screw mounting.



DIGITAL INPUT FOR START, STOP AND RESET

PSE is controlled through digital inputs using the internal 24 V DC source. This allows easy control with e.g. push buttons or relays.



OUTPUT SIGNAL RELAYS FOR RUN, TOP OF RAMP AND EVENT

Three output signal relays for indicating that the motor is running, that the softstarter is in top of ramp and if any event has happened. The relays can be used e.g. with pilot lights or to control a line contactor.



CLEAR MARKINGS ON THE FRONT FOR EASY INSTALLATION

All markings are on the front making it very easy to read after installation.

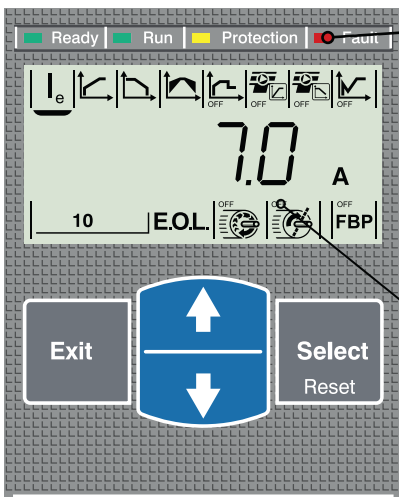

LED INDICATORS

- Green ready LED
 - Flashing - Supply available
 - Steady - Main available
- Green run LED
 - Flashing - Ramping up/down
 - Steady - TOR
- Yellow protection LED
- Red fault LED



ILLUMINATED AND LANGUAGE-NEUTRAL DISPLAY WITH ICONS

The display on PSE uses icons for fast and easy set-up of parameters. Each icon indicates a different parameter to set and makes navigation and setting of parameters easy. Set-up is done by using the four buttons on the keypad.

PSE - The efficient range

Overview



PSE18 ... PSE105

Normal start In-line connected	PSE18	PSE25	PSE30	PSE37	PSE45	PSE60	PSE72	PSE85	PSE105
(400 V) kW	7.5	11	15	18.5	22	30	37	45	55
IEC, max. A	18	25	30	37	45	60	72	85	106
(440-480 V) hp	10	15	20	25	30	40	50	60	75
UL, max. FLA	18	25	28	34	42	60	68	80	104
400 V, 40 °C									
MCCB (35 kA)									
Using MCCB only, type 1 coordination will be achieved ¹⁾	T2N160								T3N250
	MCCB (50 kA)								
T2S160									
T3S250									
To achieve type 2 coordination, semi- conductor fuses must be used ¹⁾	Fuse protection (85 kA), Semiconductor fuses, Bussmann								
	170M1563	170M1564	170M1566	170M1567	170M1568	170M1569	170M1571	170M1572	170M3819
Suitable switch fuse for recommended semi- conductor fuses ¹⁾	Switch fuse								
	OS32GD			OS63GD			OS125GD		OS250D
The line contactor is not required for the softstarter itself but often used to open if OL trips ¹⁾	Line contactor								
	AF26	AF30	AF38	AF52	AF65	AF80	AF96	AF116	

¹⁾ This is an example of coordination.

PSE - The efficient range

Overview



PSE142 ... PSE170

1SFC132002/0001



PSE210 ... PSE370

1SFC132030/0001

Normal start In-line connected (400 V) kW IEC, max. A (440-480 V) hp UL, max. FLA	PSE142	PSE170	PSE210	PSE250	PSE300	PSE370
	75	90	110	132	160	200
	143	171	210	250	300	370
	100	125	150	200	250	300
	130	169	192	248	302	361
	400 V, 40 °C					
	MCCB (35 kA)					
Using MCCB only, type 1 coordination will be achieved ¹⁾	T3N250		T4N320	T5N400		T5N630
	MCCB (50 kA)					
	T3S250		T4S320	T5S400		T5S630
To achieve type 2 coordination, semi- conductor fuses must be used ¹⁾	Fuse protection (85kA), Semiconductor fuses, Bussmann					
	170M5809	170M5810	170M5812	170M5813	170M6812	170M6813
Suitable switch fuse for recommended semi- conductor fuses ¹⁾	Switch fuse				OS400D	
					OS630D	
The line contactor is not required for the softstarter itself but often used to open if OL trips ¹⁾	Line contactor					
	AF140	AF190	AF205	AF265	AF305	AF370

¹⁾ This is an example of coordination.



PSE - The efficient range

Normal starts, class 10, in-line,
ordering details

Typical applications:

- Bow thruster
- Centrifugal pump
- Compressor
- Conveyorbelt (short)
- Elevator
- Escalator



Rated operational voltage U_e , 208...600 V

Rated control supply voltage U_c , 100...250 V AC, 50/60 Hz

IEC			UL/CSA				Type	Order code	Weight (1 pce)			
Rated operational power			Rated operational current				FLA		kg	(lb)		
230 V	400 V	500 V	200 / 208 V	220 / 240 V	440 / 480 V	550 / 600 V						
P_e kW	P_e kW	P_e kW	I_e A	P_e hp	P_e hp	P_e hp	P_e hp					
4	7.5	11	18	5	5	10	15	18	PSE18-600-70	1SFA897101R7000	2.40	(5.29)
5.5	11	15	25	7.5	7.5	15	20	25	PSE25-600-70	1SFA897102R7000	2.40	(5.29)
7.5	15	18.5	30	7.5	10	20	25	28	PSE30-600-70	1SFA897103R7000	2.40	(5.29)
9	18.5	22	37	10	10	25	30	34	PSE37-600-70	1SFA897104R7000	2.40	(5.29)
11	22	30	45	10	15	30	40	42	PSE45-600-70	1SFA897105R7000	2.40	(5.29)
15	30	37	60	20	20	40	50	60	PSE60-600-70	1SFA897106R7000	2.40	(5.29)
18.5	37	45	72	20	25	50	60	68	PSE72-600-70	1SFA897107R7000	2.50	(5.51)
22	45	55	85	25	30	60	75	80	PSE85-600-70	1SFA897108R7000	2.50	(5.51)
30	55	75	106	30	40	75	100	104	PSE105-600-70	1SFA897109R7000	2.50	(5.51)
40	75	90	143	40	50	100	125	130	PSE142-600-70	1SFA897110R7000	4.20	(9.26)
45	90	110	171	60	60	125	150	169	PSE170-600-70	1SFA897111R7000	4.20	(9.26)
59	110	132	210	60	75	150	200	192	PSE210-600-70	1SFA897112R7000	12.40	(27.34)
75	132	160	250	75	100	200	250	248	PSE250-600-70	1SFA897113R7000	13.90	(30.64)
90	160	200	300	100	100	250	300	302	PSE300-600-70	1SFA897114R7000	13.90	(30.64)
110	200	250	370	125	150	300	350	361	PSE370-600-70	1SFA897115R7000	13.90	(30.64)



PSE - The efficient range

Heavy-duty start, class 30, in-line,
ordering details

Typical applications

- Centrifugal fan
- Conveyor belt (long)
- Crusher
- Mill
- Mixer
- Stirrer







Rated operational voltage U_e , 208-600 V

Rated control supply voltage U_s , 100-250 V AC, 50/60 Hz

IEC			UL/CSA				Type	Order code	Weight (1 pce)									
Rated operational power			Rated operational current															
230 V	400 V	500 V	200 / 208 V				220 / 240 V				440 / 480 V				550 / 600 V			
P_e	P_e	P_e	I_e	P_e	P_e	P_e	P_e	P_e	P_e	FLA			kg	(lb)				
kW	kW	kW	A	hp	hp	hp	hp	hp	hp	A								
3	5.5	7.5	12	3	3	7.5	10	11	PSE18-600-70	1SFA897101R7000	2.40	(5.29)						
4	7.5	11	18	5	5	10	15	18	PSE25-600-70	1SFA897102R7000	2.40	(5.29)						
5.5	11	15	25	7.5	7.5	15	20	25	PSE30-600-70	1SFA897103R7000	2.40	(5.29)						
7.5	15	18.5	30	7.5	10	20	25	28	PSE37-600-70	1SFA897104R7000	2.40	(5.29)						
9	18.5	22	37	10	10	25	30	34	PSE45-600-70	1SFA897105R7000	2.40	(5.29)						
11	22	30	45	10	15	30	40	42	PSE60-600-70	1SFA897106R7000	2.40	(5.29)						
15	30	37	60	20	20	40	50	60	PSE72-600-70	1SFA897107R7000	2.50	(5.51)						
18.5	37	45	72	20	25	50	60	68	PSE85-600-70	1SFA897108R7000	2.50	(5.51)						
22	45	55	85	25	30	60	75	80	PSE105-600-70	1SFA897109R7000	2.50	(5.51)						
30	55	75	106	30	40	75	100	104	PSE142-600-70	1SFA897110R7000	4.20	(9.26)						
40	75	90	143	40	50	100	125	130	PSE170-600-70	1SFA897111R7000	4.20	(9.26)						
45	90	110	171	60	60	125	150	169	PSE210-600-70	1SFA897112R7000	12.40	(27.34)						
59	110	132	210	60	75	150	200	192	PSE250-600-70	1SFA897113R7000	13.90	(30.64)						
75	132	160	250	75	100	200	250	248	PSE300-600-70	1SFA897114R7000	13.90	(30.64)						
90	160	200	300	100	100	250	300	302	PSE370-600-70	1SFA897115R7000	13.90	(30.64)						

PSE - The efficient range

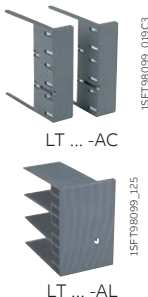
Accessories

 <p>1SFT98099_094C2 588054C2</p>	For softstarter type	Wire range	Tightening torque max.	Type	Order code	Pkg qty	Weight (1 pce)	
		mm ²	Nm				kg (lb)	
	Cable connectors for Cu cables							
	PSE142 ... PSE170	6...120	14	-	1SDA066917R1	3	0.113 (0.249)	
PSE142 ... PSE170	2 x (50...120)	16	LZ185-2C/120	1SFN074709R1000	3	0.100 (0.220)		
PSE210 ... PSE370	16...300	25	-	1SDA055016R1	3	0.133 (0.293)		
 <p>1SFT98099_01C1</p>	For softstarter type	Wire range	Tightening torque max.	Type	Order code	Pkg qty	Weight (1 pce)	
		mm ²	Nm				kg (lb)	
	Cable connectors for Al and Cu cables							
	PSE142 ... PSE170	95...185	31	-	1SDA054988R1	3	0.078 (0.172)	
PSE210 ... PSE370	185...240	43	-	1SDA055020R1	3	0.133 (0.293)		
 <p>LW... 1SFT98000_011C3</p>	For softstarter type	Dimensions hole ø	bar mm ²	Type	Order code	Pkg qty	Weight (1 pce)	
		mm ²					kg (lb)	
	Terminal enlargements							
	PSE18 ... PSE105	6.5	15 x 3	LW110	1SFN074307R1000	1	0.100 (0.220)	
PSE142 ... PSE170	10.5	17.5 x 5	LW185	1SFN074707R1000	1	0.450 (0.992)		
PSE210 ... PSE370	10.5	20 x 5	LW300	1SFN075107R1000	1	1.230 (2.712)		
 <p>LT ... -AC 1SFT98099_019C3 LT ... -AL 1SFT98099_125</p>	For softstarter type		Req. qty	Type	Order code	Pkg qty	Weight (1 pce)	
							kg (lb)	
	Terminal shrouds							
	PSE142 ... PSE170, short for use with cable clamps		2	LT185-AC	1SFN124701R1000	2	0.050 (0.110)	
	PSE142 ... PSE170, long for use with compression lugs		2	LT185-AL	1SFN124703R1000	2	0.220 (0.485)	
	PSE210 ... PSE370, short for use with cable clamps		2	LT300-AC	1SFN125101R1000	2	0.070 (0.154)	
PSE210 ... PSE370, long for use with compression lugs		2	LT300-AL	1SFN125103R1000	2	0.280 (0.617)		
 <p>1SFC13228F0002 PSEEK</p>	For softstarter type			Type	Order code	Pkg qty	Weight (1 pce)	
							kg (lb)	
External keypad including a 3m cable								
PSE18 ... PSE370			PSEEK	1SFA897100R1001	1	0.198 (0.437)		
 <p>1SFC13235F0002 PSECA</p>	For softstarter type			Type	Order code	Pkg qty	Weight (1 pce)	
							kg (lb)	
USB cable for Service Engineer Tool								
PSE18 ... PSE370			PSECA	1SFA897201R1001	1	0.130 (0.287)		

PSE - The efficient range

Technical data

Tripping curves for the integrated electronic overload protection

PSE has an integrated electronic overload protection that can be set to four different tripping classes. Below you find a curve for each tripping class in cold state.

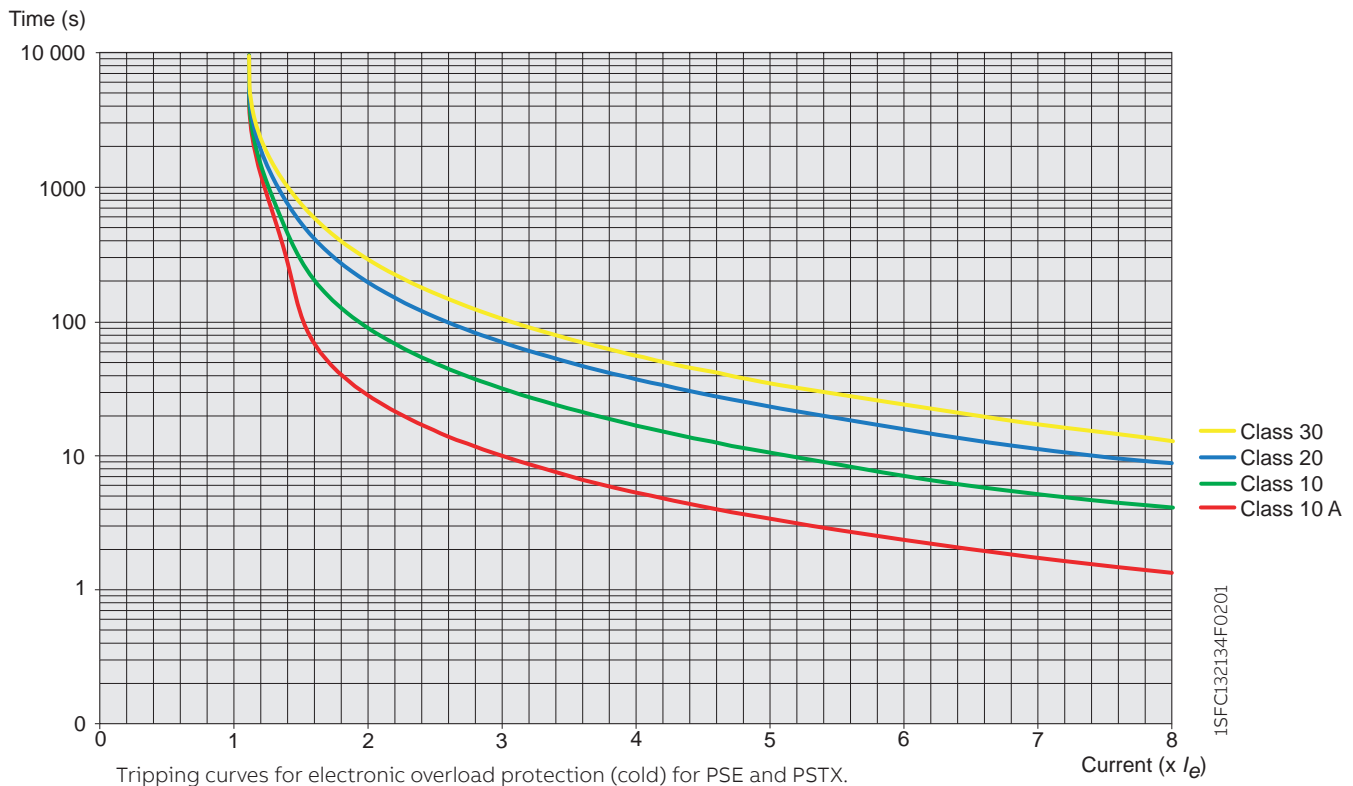

PSE - The efficient range

Technical data

Softstarter type		PSE18 ... PSE370
Rated insulation voltage U_i		600 V
Rated operational voltage U_e		208...600 V +10%/-15%
Rated control supply voltage U_c		100...250 V +10%/-15%, 50/60 Hz \pm 10 %
Rated control circuit voltage U_c		Internal 24 V DC
Starting capacity at I_e		4 x I_e for 10 sec.
Number of starts per hour		10 ¹⁾
Overload capability	Overload class	10
Ambient temperature	During operation	-25...+60 °C (-13...+140 F) ²⁾
	During storage	-40...+70 °C (-40...+158 F)
Maximum Altitude		4000 m (13123 ft) ³⁾
Degree of protection	Main circuit	IP00
	Supply and control circuit	IP20
Main circuit	Built-in bypass	Yes
	Cooling system - fan cooled (thermostat controlled)	Yes
HMI for settings	Display	4 7-segments and icons. Illuminated
	Keypad	2 selection keys and 2 navigation keys
Main settings	Setting current	Size dependent
	Ramp time during start	1...30 sec
	Ramp time during stop	0...30 sec
	Initial/end voltage	30...70%
	Current limit	1.5...7 x I_e
	Torque control for start	Yes / No
	Torque control for stop	Yes / No
	Kick start	Off, 30...100%
Signal relays	Number of signal relays	3
	K2	Run signal
	K3	TOR (bypass) signal
	K1	Event signal
	Rated operational voltage U_e	250 V AC/24 V DC ⁴⁾
	Rated thermal current I_{th}	3 A
Analog output	Rated operational current I_e at AC-15 ($U_e = 250$ V)	1.5 A
	Output signal reference	4...20 mA
	Type of output signal	I Amp
Control circuit	Number of inputs	3 (start, stop, reset of faults)
	Scaling	Fixed at 1.2 x I_e
Signal indication LED	On / Ready	Green flashing / steady
	Run / TOR	Green flashing / steady
	Protection	Yellow
	Fault	Red
Protections	Electronic overload	Yes (Class 10A, 10, 20, 30)
	Locked rotor protection	Yes
	Underload protection	Yes
Fieldbus connection	Connection for ABB FieldBusPlug	Yes (option)
External keypad	Display	LCD type
	Ambient temperature	
	During operation	-25...+60 °C (-13...+140 F)
	During storage	-40...+70 °C (-40...+158 F)
	Degree of protection	IP66

¹⁾ Valid for 50% on time and 50% off time. If other data is required, contact your local ABB office.







²⁾ Above 40 °C (104 F) up to max. 60 °C (140 F) reduce the rated current with 0.6% per °C (0,33% per F).

³⁾ When used at high altitudes, above 1000 meters (3281 ft) up to 4000 meters (13123 ft), de-rate the rated current using the following formula. [% of $I_e = 100 - \frac{x - 1000}{1000}$] x = actual altitude of the softstarter in meters.

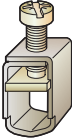
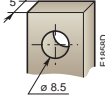
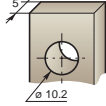
⁴⁾ A common voltage needs to be used for all 3 signal relays.

PSE - The efficient range

Technical data

Main terminals		PSE18 ... PSE105	PSE142 ... PSE170	PSE210 ... PSE370
				
	Cu cable - Flexible 1 x mm ²	2.5...70 mm ²	6...120 mm ²	16...300 mm ²
	Clamp type	Included	1SDA066917R1	1SDA055016R1
	Tightening torque	8 Nm	14 Nm	25 Nm
	Cu cable - Flexible 2 x mm ²	2.5...70 mm ²	50...120 mm ²	-
	Clamp type	Included	1SFN074709R1000	-
	Tightening torque	8 Nm	16 Nm	-
	Cu cable - Stranded 1 x mm ²	2.5...70 mm ²	6...120 mm ²	16...300 mm ²
	Clamp type	Included	1SDA066917R1	1SDA055016R1
	Tightening torque	8 Nm	14 Nm	25 Nm
	Cu cable - Stranded 2 x mm ²	2.5...70 mm ²	50...120 mm ²	-
	Clamp type	Included	1SFN074709R1000	-
	Tightening torque	8 Nm	16 Nm	-
	Al cable - Stranded 1 x mm ²	-	95...185 mm ²	185...240
	Clamp type	-	1SDA054988R1	1SDA055020R1
	Tightening torque	-	31 Nm	43 Nm
	Lugs	Width	24 mm (0.945 in)	30 mm (1.181 in)
		Diameter >=	8.5 mm (0.335 in)	10.2 mm (0.402 in)
		Tightening torque	18 Nm (159 in lb)	28 Nm (248 in lb)
Connection capacity acc to UL / CSA 1 x AWG / kcmil		6...2/0	6...300 kcmil	4...400 kcmil
	Clamp type	Included	ATK185	ATK300
	Tightening torque	71 in lb	300 in lb	375 in lb
Connection capacity acc to UL / CSA 2 x AWG / kcmil		-	-	4...500 kcmil
	Clamp type	-	-	ATK300/2
	Tightening torque	-	-	375 in lb
Supply and control circuit		Cu cable - Stranded 1 x mm ²	0.75...2.5 mm ² (19...14 AWG)	
		Cu cable - Stranded 2 x mm ²	0.75...1.5 mm ² (19...16 AWG)	
		Tightening torque	0.5 Nm (4.4 in lb)	

Fuse ratings and power losses

For softstarter	Current range	Max power loss at rated I _e	Max fuse rating - main circuit ¹⁾			Power requirements supply circuit Holding (VA) / Pull-in (VA)
			Bussmann fuses, DIN43 620 (Knife)			
Type	A	W	A	Type	Size	
PSE18	5.4...18.0	0.2	40	170M1563	000	16/19.9
PSE25	7.5...25.0	0.4	50	170M1564	000	16/19.9
PSE30	9.0...30.0	0.5	80	170M1566	000	16/19.9
PSE37	11.1...37.0	0.8	100	170M1567	000	16/19.9
PSE45	13.5...45.0	1.2	125	170M1568	000	16/19.9
PSE60	18.0...60.0	2.2	160	170M1569	000	16/19.9
PSE72	21.6...72.0	3.1	250	170M1571	000	16/19.9
PSE85	25.5...85.0	4.3	315	170M1572	000	16/19.9
PSE105	31.8...106.0	6.6	400	170M3819	1*	16/19.9
PSE142	42.9...143.0	12.1	450	170M5809	2	16/31
PSE170	51.3...171.0	17.6	500	170M5810	2	16/31
PSE210	63.0...210.0	8.8	630	170M5812	2	30/716
PSE250	75.0...250.0	12.5	700	170M5813	2	30/716
PSE300	90.6...302.0	18.0	800	170M6812	3	30/716
PSE370	111.0...370.0	27.4	900	170M6813	3	30/716

¹⁾ For the supply circuit 6 A delayed, for MCB use C characteristics.

PSE - The efficient range

Dimensions

PSE18 ... PSE105

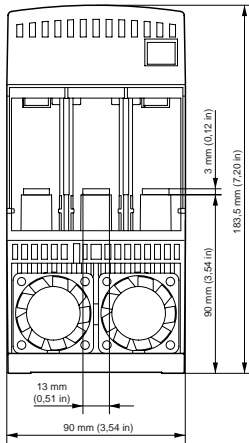

PSE142 ... PSE170

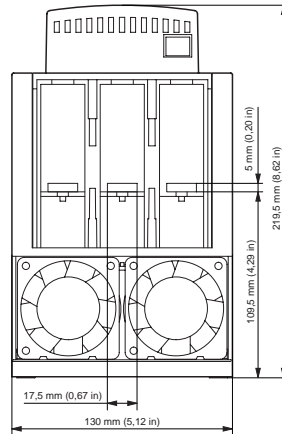

PSE210 ... PSE370

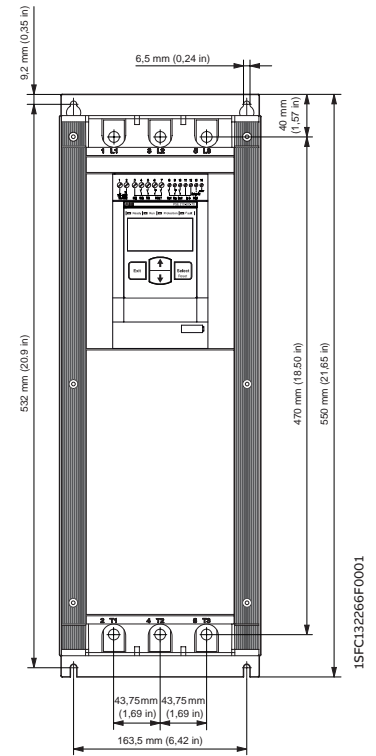
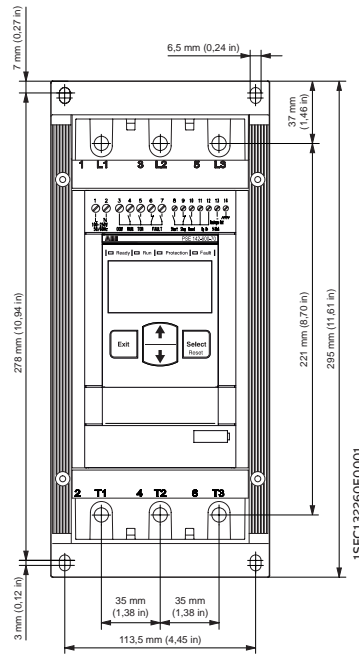
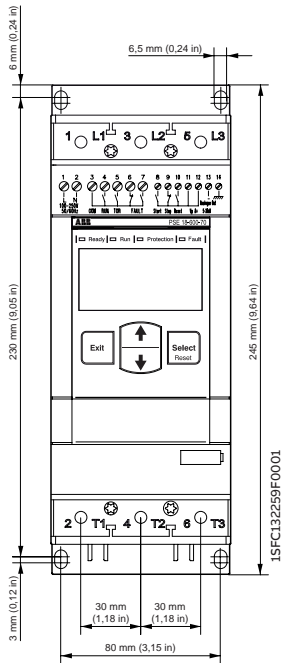
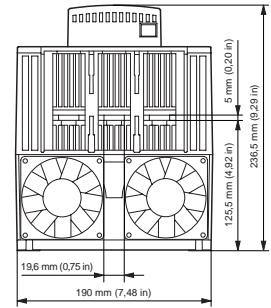

PSE external keypad (PSEEK)

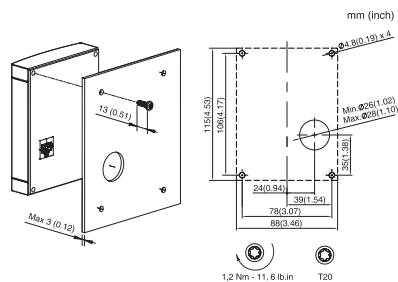
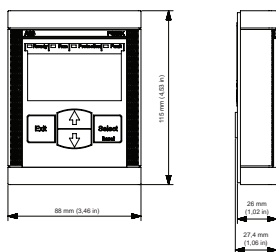

PSE - The efficient range

Circuit diagrams

PSE18 ... PSE370
With MCCB and line contactor

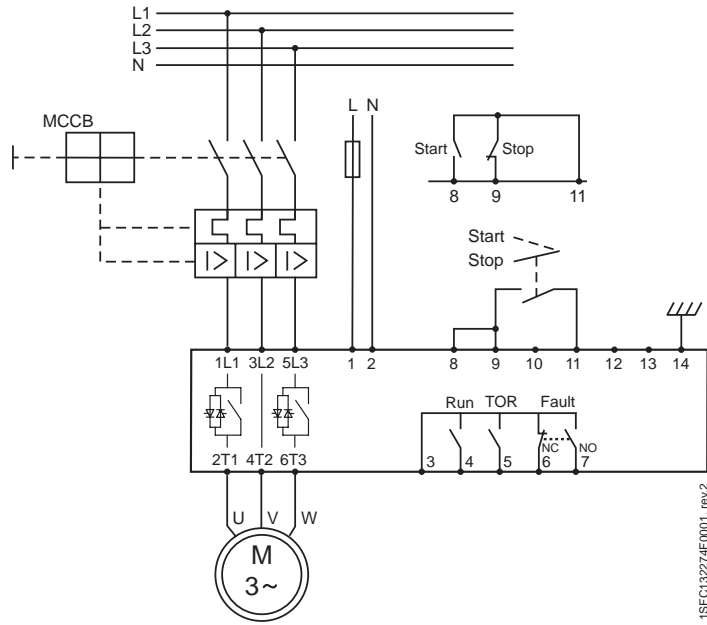

With fuses and line contactor

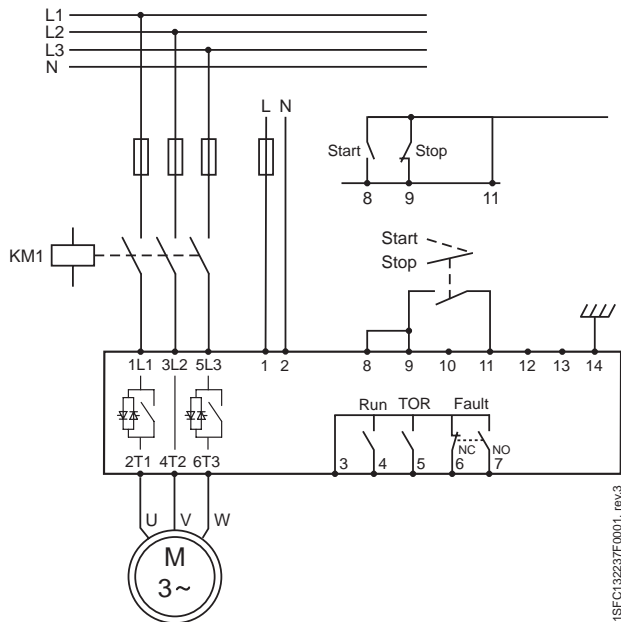



The PSTX combines many years of research and product development with extensive knowledge of application specific requirements and needs. It is our latest advancement in motor control & protection, and it adds new functionality and increased reliability.

PSTX - The advance range

40–41	Introduction
42–43	Overview
44–47	Ordering details
48–49	Accessories
50–53	Technical data
54–55	Dimensions
56–57	Circuit diagrams

PSTX - The advanced range

Introduction



- Three-phase controlled
- Operational voltage: 208 – 690 VAC
- Wide rated control supply voltage: 100 – 250 V, 50/60 Hz
- PSTX rated operational current: 30 to 1250 A
- (inside-delta: 2160 A)
- Both in-line and inside-delta connection
- Coated circuit boards
- protecting from dust, moist and
- corrosive atmosphere
- Detachable keypad rated IP66 (Type 1, 4X,12)
- Graphical display with 17 languages for easy setup and operation
- Built-in bypass for energy saving and easy installation
- Built-in Modbus RTU for monitoring and control
- Support for all major communication protocols
- Analog output for measurement of current, voltage, power factor etc.

SECURE MOTOR

Reliability



COMPLETE MOTOR PROTECTION

The PSTX offers complete motor protection in only one unit and is able to handle both load and network irregularities. PT-100, earth fault protection and over/under voltage protection along with many other functions keep your motor safer than ever.

THREE TYPES OF CURRENT LIMIT

PSTX offers three types of current limit: standard, dual and ramp. This gives you full control of your motor during start. It also allows you to use your motor in weaker networks.

IMPROVE INSTALLATION

Efficiency



BUILT-IN BYPASS SAVES TIME AND ENERGY

When reaching full speed, the PSTX will activate its bypass. This saves energy while reducing the softstarter's heat generation. On the PSTX, the bypass is built in and verified by ABB, saving you time during installation and space in your panel.

EASY-TO-USE AND DETACHABLE KEYPAD

A user-friendly and clear display saves you time and resources during both setup and operation. The detachable keypad is standard on all PSTX softstarters.

INCREASE APPLICATION

Productivity



COMPLETE CONTROL OF PUMPS

Time to use your processes to their full potential. The PSTX features many application enhancing features, including torque control: the most efficient way to start and stop pumps. The pump cleaning feature can reverse pump flow and clean out pipes, securing uptime of your pump system.

JOG WITH SLOW SPEED

The slow speed forward and backward jog feature will make you more flexible when operating e.g. conveyor belts and cranes. The PSTX provides positioning capabilities, letting you take control of your process.



KEYHOLE MOUNTING FOR QUICK INSTALLATION

The PSTX is simple and quick to install using keyhole mounting, saving you valuable time during the installation.



A COMPACT MOTOR STARTING SOLUTION

When your application reaches full speed, a bypass will reduce the softstarter's energy consumption. It also reduces heat generation which means you can save money by reducing the need of added cooling equipment. On the PSTX, the bypass is built in and verified by ABB.



CLEAR MARKINGS ON THE FRONT

With the PSTX, you do not need a manual to handle control circuit connections. With the self-explanatory markings on the front you can verify that the connections are done right. And with basic data on the front, identification is simple without having to take the product down.



CUSTOMIZABLE

The PSTX has 15 pre-installed languages along with options to customize your own specific home screens (up to seven different). You can use your customized home screens to show status information important to your process and hide information that is not.



EASY TO LEARN

A large graphical display along with built-in assistants make learning how to handle the PSTX fun and simple. The interface resembles other interfaces from ABB which will streamline and help with training of field personnel.



DETACHABLE

The PSTX comes with a detachable keypad as standard. It can be placed on your panel door, meaning you do not have to interrupt your process in order to read status information or to change settings.

PSTX - The advanced range

Overview



PSTX30... PSTX105



PSTX142... PSTX170

	PSTX30	PSTX37	PSTX45	PSTX60	PSTX72	PSTX85	PSTX105	PSTX142	PSTX170
Normal start									
In-Line connected (400 V) kW	15	18.5	22	30	37	45	55	75	90
IEC, max. A	30	37	45	60	72	85	106	143	171
(440-480 V) hp	20	25	30	40	50	60	75	100	125
UL, max. FLA	28	34	42	60	68	80	104	130	169
400 V, 40 °C									
Using manual motor starter or MCCB, type 1 coordination will be achieved.¹⁾	MCCB (50 kA)								
	XT2S160								XT4S250
Using gG fuses, type 1 coordination will be achieved. To achieve type 2 coordination, semiconductor fuses must be used.¹⁾	Fuse protection (80 kA), Semiconductor fuses, Bussmann								
	170M1567	170M1568	170M1569		170M1571	170M1572	170M3819	170M5810	170M5812
Suitable switch fuse for the recommended semiconductor fuses.¹⁾	Switch fuse								
	OS32G	OS63G			OS125G		OS250	OS400	
The line contactor is not required for the softstarter itself but often used to open if OL trips¹⁾	Line contactor								
	AF30	AF38	AF52	AF65	AF80	AF96	AF116	AF140	AF190

¹⁾ This is an example of coordination.

PSTX - The advanced range

Overview



	PSTX210	PSTX250	PSTX300	PSTX370	PSTX470	PSTX570	PSTX720	PSTX840	PSTX1050	PSTX1250
Normal start										
In-Line connected (400 V) kW	110	132	160	200	250	315	400	450	560	710
IEC, max. A (440-480 V) hp	210	250	300	370	470	570	720	840	1050	1250
UL, max. FLA	150	200	250	300	400	500	600	700	900	1000
	192	248	302	361	480	590	720	840	1062	1250
400 V, 40 °C										
Using manual motor starter or MCCB, type 1 coordination will be achieved.¹⁾	MCCB (50 kA)									
	T4S320	T5S400		T5S630	T7S800		T7S1250		E2.2N 2000	
Using gG fuses, type 1 coordination will be achieved. To achieve type 2 coordination, semiconductor fuses must be used.¹⁾	Fuse protection (80 kA), Semiconductor fuses, Bussmann									
	170M5812	170M5813	170M6812	170M6813		170M6814	170M8554	170M6018	170M6020	170M6021
Suitable switch fuse for the recommended semiconductor fuses.¹⁾	Switch fuse									
	OS400		OS630			OS800		-		
The line contactor is not required for the softstarter itself but often used to open if OL trips.¹⁾	Line contactor									
	AF205	AF265	AF305	AF370	AF460	AF580	AF750	AF1350	AF1650	-

¹⁾ This is an example of coordination.



PSTX - The advanced range

Normal starts, class 10, in-line,

Ordering details

Typical applications

- Bow thruster
- Centrifugal pump
- Compressor
- Conveyor belt (short)
- Elevator



PSTX30 ... PSTX105 PSTX142 ... PSTX170 PSTX210 ... PSTX370 PSTX470 ... PSTX570 PSTX720 ... PSTX840 PSTX1050 ... PSTX1250

Rated operational voltage U_e , 208...600 V , Rated control supply voltage U_s , 100...250 V AC, 50/60 Hz

IEC			UL/CSA				Type			Order code	Weight (1 pce)	
Rated operational power			Rated operational current									
400V	500V	690V	200/208V 220/240V 440/480V 550/600V									
Pe	Pe	Pe	Ie	Pe	Pe	Pe	Pe	Pe	FLA			
kW	kW	kW	A	hp	hp	hp	hp	hp	A			
15	18.5	-	30	7.5	10	20	25	28	PSTX30-600-70	1SFA898103R7000	6.10	(13.45)
18.5	22	-	37	10	10	25	30	34	PSTX37-600-70	1SFA898104R7000	6.10	(13.45)
22	25	-	45	10	15	30	40	42	PSTX45-600-70	1SFA898105R7000	6.10	(13.45)
30	37	-	60	20	20	40	50	60	PSTX60-600-70	1SFA898106R7000	6.10	(13.45)
37	45	-	72	20	25	50	60	68	PSTX72-600-70	1SFA898107R7000	6.10	(13.45)
45	55	-	85	25	30	60	75	80	PSTX85-600-70	1SFA898108R7000	6.10	(13.45)
55	75	-	106	30	40	75	100	104	PSTX105-600-70	1SFA898109R7000	6.10	(13.45)
75	90	-	143	40	50	100	125	130	PSTX142-600-70	1SFA898110R7000	9.60	(21.16)
90	110	-	171	50	60	125	150	169	PSTX170-600-70	1SFA898111R7000	9.60	(21.16)
110	132	-	210	60	75	150	200	192	PSTX210-600-70	1SFA898112R7000	12.70	(27.99)
132	160	-	250	75	100	200	250	248	PSTX250-600-70	1SFA898113R7000	12.70	(27.99)
160	200	-	300	100	100	250	300	302	PSTX300-600-70	1SFA898114R7000	12.70	(27.99)
200	257	-	370	125	150	300	350	361	PSTX370-600-70	1SFA898115R7000	12.70	(27.99)
250	315	-	470	150	200	400	500	480	PSTX470-600-70	1SFA898116R7000	25.00	(55.12)
315	400	-	570	200	200	500	600	590	PSTX570-600-70	1SFA898117R7000	25.00	(55.12)
400	500	-	720	250	300	600	700	720	PSTX720-600-70	1SFA898118R7000	46.20	(101.85)
450	600	-	840	300	350	700	800	840	PSTX840-600-70	1SFA898119R7000	46.20	(101.85)
560	730	-	1050	400	450	900	1000	1062	PSTX1050-600-70	1SFA898120R7000	64.20	(141.54)
710	880	-	1250	400	500	1000	1200	1250	PSTX1250-600-70	1SFA898121R7000	64.70	(142.64)

Rated operational voltage U_e , 208...690 V , Rated control supply voltage U_s , 100...250 V AC, 50/60 Hz

15	18.5	25	30	7.5	10	20	25	28	PSTX30-690-70	1SFA898203R7000	6.10	(13.45)
18.5	22	30	37	10	10	25	30	34	PSTX37-690-70	1SFA898204R7000	6.10	(13.45)
22	25	37	45	10	15	30	40	42	PSTX45-690-70	1SFA898205R7000	6.10	(13.45)
30	37	55	60	20	20	40	50	60	PSTX60-690-70	1SFA898206R7000	6.10	(13.45)
37	45	59	72	20	25	50	60	68	PSTX72-690-70	1SFA898207R7000	6.10	(13.45)
45	55	75	85	25	30	60	75	80	PSTX85-690-70	1SFA898208R7000	6.10	(13.45)
55	75	90	106	30	40	75	100	104	PSTX105-690-70	1SFA898209R7000	6.10	(13.45)
75	90	132	143	40	50	100	125	130	PSTX142-690-70	1SFA898210R7000	9.60	(21.16)
90	110	160	171	50	60	125	150	169	PSTX170-690-70	1SFA898211R7000	9.60	(21.16)
110	132	184	210	60	75	150	200	192	PSTX210-690-70	1SFA898212R7000	12.70	(27.99)
132	160	220	250	75	100	200	250	248	PSTX250-690-70	1SFA898213R7000	12.70	(27.99)
160	200	257	300	100	100	250	300	302	PSTX300-690-70	1SFA898214R7000	12.70	(27.99)
200	257	355	370	125	150	300	350	361	PSTX370-690-70	1SFA898215R7000	12.70	(27.99)
250	315	450	470	150	200	400	500	480	PSTX470-690-70	1SFA898216R7000	25.00	(55.12)
315	400	560	570	200	200	500	600	590	PSTX570-690-70	1SFA898217R7000	25.00	(55.12)
400	500	710	720	250	300	600	700	720	PSTX720-690-70	1SFA898218R7000	46.20	(101.85)
450	600	800	840	300	350	700	800	840	PSTX840-690-70	1SFA898219R7000	46.20	(101.85)
560	730	1000	1050	400	450	900	1000	1062	PSTX1050-690-70	1SFA898220R7000	64.20	(141.54)
710	880	1200	1250	400	500	1000	1200	1250	PSTX1250-690-70	1SFA898221R7000	64.70	(142.64)



PSTX - The advanced range

Heavy-duty, class 30, in-line,
Ordering details

Typical applications

- Centrifugal fan
- Conveyor belt (long)
- Crusher
- Mill
- Mixer
- Stirrer



Rated operational voltage U_e , 208...600 V, Rated control supply voltage U_s , 100...250 V AC, 50/60 Hz

IEC			UL/CSA				Type	Order code	Weight (1 pce)			
Rated operational power			Rated operational current				FLA					
400V	500V	690V	200/208 V	220/240 V	440/480 V	550/600 V						
P_e kW	P_e kW	P_e kW	I_e A	P_e hp	P_e hp	P_e hp	P_e hp	A	kg	(lb)		
11	15	-	22	5	7.5	15	20	25	PSTX30-600-70	1SFA898103R7000	6.10	(13.45)
15	18.5	-	30	7.5	10	20	25	28	PSTX37-600-70	1SFA898104R7000	6.10	(13.45)
18.5	22	-	37	10	10	25	30	34	PSTX45-600-70	1SFA898105R7000	6.10	(13.45)
22	25	-	45	10	15	30	40	42	PSTX60-600-70	1SFA898106R7000	6.10	(13.45)
30	37	-	60	20	20	40	50	60	PSTX72-600-70	1SFA898107R7000	6.10	(13.45)
37	45	-	72	20	25	50	60	68	PSTX85-600-70	1SFA898108R7000	6.10	(13.45)
45	55	-	85	25	30	60	75	80	PSTX105-600-70	1SFA898109R7000	6.10	(13.45)
55	75	-	106	30	40	75	100	104	PSTX142-600-70	1SFA898110R7000	9.60	(21.16)
75	90	-	143	40	50	100	125	130	PSTX170-600-70	1SFA898111R7000	9.60	(21.16)
90	110	-	171	50	60	125	150	169	PSTX210-600-70	1SFA898112R7000	12.70	(27.99)
110	132	-	210	60	75	150	200	192	PSTX250-600-70	1SFA898113R7000	12.70	(27.99)
132	160	-	250	75	100	200	250	248	PSTX300-600-70	1SFA898114R7000	12.70	(27.99)
160	200	-	300	100	100	250	300	302	PSTX370-600-70	1SFA898115R7000	12.70	(27.99)
200	257	-	370	125	150	300	350	361	PSTX470-600-70	1SFA898116R7000	25.00	(55.12)
250	315	-	470	150	200	400	500	480	PSTX570-600-70	1SFA898117R7000	25.00	(55.12)
315	400	-	570	200	200	500	600	590	PSTX720-600-70	1SFA898118R7000	46.20	(101.85)
400	500	-	720	250	300	600	700	720	PSTX840-600-70	1SFA898119R7000	46.20	(101.85)
450	600	-	840	300	350	700	800	840	PSTX1050-600-70	1SFA898120R7000	64.20	(141.54)
560	730	-	1050	400	450	900	1000	1062	PSTX1250-600-70	1SFA898121R7000	64.70	(142.64)

Rated operational voltage U_e , 208...690 V, Rated control supply voltage U_s , 100...250 V AC, 50/60 Hz

11	15	18.5	22	5	7.5	15	20	25	PSTX30-690-70	1SFA898203R7000	6.10	(13.45)
15	18.5	25	30	7.5	10	20	25	28	PSTX37-690-70	1SFA898204R7000	6.10	(13.45)
18.5	22	30	37	10	10	25	30	34	PSTX45-690-70	1SFA898205R7000	6.10	(13.45)
22	25	37	44	10	15	30	40	42	PSTX60-690-70	1SFA898206R7000	6.10	(13.45)
30	37	55	60	20	20	40	50	60	PSTX72-690-70	1SFA898207R7000	6.10	(13.45)
37	45	59	72	20	25	50	60	68	PSTX85-690-70	1SFA898208R7000	6.10	(13.45)
45	55	75	85	25	30	60	75	80	PSTX105-690-70	1SFA898209R7000	6.10	(13.45)
55	75	90	106	30	40	75	100	104	PSTX142-690-70	1SFA898210R7000	9.60	(21.16)
75	90	132	143	40	50	100	125	130	PSTX170-690-70	1SFA898211R7000	9.60	(21.16)
90	110	160	171	50	60	125	150	169	PSTX210-690-70	1SFA898212R7000	12.70	(27.99)
110	132	184	210	60	75	150	200	192	PSTX250-690-70	1SFA898213R7000	12.70	(27.99)
132	160	220	250	75	100	200	250	248	PSTX300-690-70	1SFA898214R7000	12.70	(27.99)
160	200	257	300	100	100	250	300	302	PSTX370-690-70	1SFA898215R7000	12.70	(27.99)
200	257	355	370	125	150	300	350	361	PSTX470-690-70	1SFA898216R7000	25.00	(55.12)
250	315	450	470	150	200	400	500	480	PSTX570-690-70	1SFA898217R7000	25.00	(55.12)
315	400	560	570	200	200	500	600	590	PSTX720-690-70	1SFA898218R7000	46.20	(101.85)
400	500	710	720	250	300	600	700	720	PSTX840-690-70	1SFA898219R7000	46.20	(101.85)
450	600	800	840	300	350	700	800	840	PSTX1050-690-70	1SFA898220R7000	64.20	(141.54)
560	730	1000	1050	400	450	900	1000	1062	PSTX1250-690-70	1SFA898221R7000	64.70	(142.64)

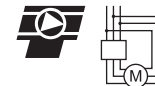

PSTX - The advanced range

Normal starts, class 10, inside delta,
ordering details

Typical applications:

- Bow thruster
- Centrifugal pump
- Compressor
- Conveyor belt (short)
- Elevator



PSTX30 ... PSTX105 PSTX142 ... PSTX170 PSTX210 ... PSTX370 PSTX470 ... PSTX570 PSTX720 ... PSTX840 PSTX1050 ... PSTX1250

Rated operational voltage U_e , 208...600 V, Rated control supply voltage U_s , 100...250 V AC, 50/60 Hz

IEC				UL/CSA				Type	Order code	Weight (1 pce)		
Rated operational power		Rated operational current	Rated operational power		Rated operational current							
400 V	500 V	690 V		200/208V	220/240V	440/480V	550/600V			kg	(lb)	
P_e kW	P_e kW	P_e kW	I_e A	P_e hp	P_e hp	P_e hp	P_e hp	FLA A				
25	30	-	52	10	15	30	40	48	PSTX30-600-70	1SFA898103R7000	6.10	(13.45)
30	37	-	64	15	20	40	50	58	PSTX37-600-70	1SFA898104R7000	6.10	(13.45)
37	45	-	76	20	25	50	60	72	PSTX45-600-70	1SFA898105R7000	6.10	(13.45)
55	75	-	105	30	40	75	100	103	PSTX60-600-70	1SFA898106R7000	6.10	(13.45)
59	80	-	124	30	40	75	100	117	PSTX72-600-70	1SFA898107R7000	6.10	(13.45)
75	90	-	147	40	50	100	125	138	PSTX85-600-70	1SFA898108R7000	6.10	(13.45)
90	110	-	181	60	60	150	150	180	PSTX105-600-70	1SFA898109R7000	6.10	(13.45)
132	160	-	245	75	75	150	200	225	PSTX142-600-70	1SFA898110R7000	9.60	(21.16)
160	200	-	300	75	100	200	250	292	PSTX170-600-70	1SFA898111R7000	9.60	(21.16)
184	250	-	360	100	125	250	300	332	PSTX210-600-70	1SFA898112R7000	12.70	(27.99)
220	295	-	430	150	150	350	450	429	PSTX250-600-70	1SFA898113R7000	12.70	(27.99)
257	355	-	515	150	200	450	500	523	PSTX300-600-70	1SFA898114R7000	12.70	(27.99)
355	450	-	640	200	250	500	600	625	PSTX370-600-70	1SFA898115R7000	12.70	(27.99)
450	600	-	814	250	300	600	700	830	PSTX470-600-70	1SFA898116R7000	25.00	(55.12)
540	700	-	987	300	350	700	800	1020	PSTX570-600-70	1SFA898117R7000	25.00	(55.12)
710	880	-	1247	400	500	1000	1200	1240	PSTX720-600-70	1SFA898118R7000	46.20	(101.85)
800	1000	-	1455	500	600	1200	1500	1450	PSTX840-600-70	1SFA898119R7000	46.20	(101.85)
1000	1250	-	1810	600	700	1500	1800	1830	PSTX1050-600-70	1SFA898120R7000	64.20	(141.54)
1200	1500	-	2160	800	900	1800	2000	2160	PSTX1250-600-70	1SFA898121R1000	64.70	(142.64)

Rated operational voltage U_e , 208...690 V, Rated control supply voltage U_s , 100...250 V AC, 50/60 Hz

25	30	45	52	10	15	30	40	48	PSTX30-690-70	1SFA898203R7000	6.10	(13.45)
30	37	55	64	15	20	40	50	58	PSTX37-690-70	1SFA898204R7000	6.10	(13.45)
37	45	59	76	20	25	50	60	72	PSTX45-690-70	1SFA898205R7000	6.10	(13.45)
55	75	90	105	30	40	75	100	103	PSTX60-690-70	1SFA898206R7000	6.10	(13.45)
59	80	110	124	30	40	75	100	117	PSTX72-690-70	1SFA898207R7000	6.10	(13.45)
75	90	132	147	40	50	100	125	138	PSTX85-690-70	1SFA898208R7000	6.10	(13.45)
90	110	160	181	60	60	150	150	180	PSTX105-690-70	1SFA898209R7000	6.10	(13.45)
132	160	220	245	75	75	150	200	225	PSTX142-690-70	1SFA898210R7000	9.60	(21.16)
160	200	257	300	75	100	200	250	292	PSTX170-690-70	1SFA898211R7000	9.60	(21.16)
184	250	315	360	100	125	250	300	332	PSTX210-690-70	1SFA898212R7000	12.70	(27.99)
220	295	400	430	150	150	350	450	429	PSTX250-690-70	1SFA898213R7000	12.70	(27.99)
257	355	500	515	150	200	450	500	523	PSTX300-690-70	1SFA898214R7000	12.70	(27.99)
355	450	600	640	200	250	500	600	625	PSTX370-690-70	1SFA898215R7000	12.70	(27.99)
450	600	800	814	250	300	600	700	830	PSTX470-690-70	1SFA898216R7000	25.00	(55.12)
540	700	960	987	300	350	700	800	1020	PSTX570-690-70	1SFA898217R7000	25.00	(55.12)
710	880	1200	1247	400	500	1000	1200	1240	PSTX720-690-70	1SFA898218R7000	46.20	(101.85)
800	1000	1400	1455	500	600	1200	1500	1450	PSTX840-690-70	1SFA898219R7000	46.20	(101.85)
1000	1250	1700	1810	600	700	1500	1800	1830	PSTX1050-690-70	1SFA898220R7000	64.20	(141.54)
1200	1500	2000	2160	800	900	1800	2000	2160	PSTX1250-690-70	1SFA898221R7000	64.70	(142.64)

PSTX - The advanced range

Normal starts, class 30, inside delta, ordering details



Typical applications:

- Centrifugal fan
- Conveyor belt (long)
- Crusher
- Mill
- Mixer
- Stirrer



PSTX30 ... PSTX105 PSTX142 ... PSTX170 PSTX210 ... PSTX370 PSTX470 ... PSTX570 PSTX720 ... PSTX840 PSTX1050 ... PSTX1250

Rated operational voltage U_e , 208...600 V, Rated control supply voltage U_s , 100...250 V AC, 50/60 Hz







IEC		UL/CSA				Type				Order code	Weight			
Rated operational power		Rated operational current				Rated operational power				current		(1 pce)		
400 V 500 V 690 V		200/208V 220/240V 440/480V 550/ 600V												
P_e	P_e	P_e	I_e	A	P_e	hp	P_e	hp	P_e	hp	FLA	A	kg	(lb)
18.5	25	-	42	7.5	10	25	30	34	PSTX30-600-70	1SFA898103R7000	6.10	(13.45)		
25	30	-	52	10	15	30	40	48	PSTX37-600-70	1SFA898104R7000	6.10	(13.45)		
30	37	-	64	15	20	40	50	58	PSTX45-600-70	1SFA898105R7000	6.10	(13.45)		
37	45	-	76	20	25	50	60	72	PSTX60-600-70	1SFA898106R7000	6.10	(13.45)		
55	75	-	105	30	40	75	100	103	PSTX72-600-70	1SFA898107R7000	6.10	(13.45)		
59	80	-	124	30	40	75	100	117	PSTX85-600-70	1SFA898108R7000	6.10	(13.45)		
75	90	-	147	40	50	100	125	138	PSTX105-600-70	1SFA898109R7000	6.10	(13.45)		
90	110	-	181	60	60	150	150	180	PSTX142-600-70	1SFA898110R7000	9.60	(21.16)		
132	160	-	245	75	75	150	200	225	PSTX170-600-70	1SFA898111R7000	9.60	(21.16)		
160	200	-	300	75	100	200	250	292	PSTX210-600-70	1SFA898112R7000	12.70	(27.99)		
184	250	-	360	100	125	250	300	332	PSTX250-600-70	1SFA898113R7000	12.70	(27.99)		
220	295	-	430	150	150	350	450	429	PSTX300-600-70	1SFA898114R7000	12.70	(27.99)		
257	355	-	515	150	200	450	500	523	PSTX370-600-70	1SFA898115R7000	12.70	(27.99)		
355	450	-	640	200	250	500	600	625	PSTX470-600-70	1SFA898116R7000	25.00	(55.12)		
450	600	-	814	250	300	600	700	830	PSTX570-600-70	1SFA898117R7000	25.00	(55.12)		
540	700	-	987	300	350	700	800	1020	PSTX720-600-70	1SFA898118R7000	46.20	(101.85)		
710	880	-	1247	400	500	1000	1200	1240	PSTX840-600-70	1SFA898119R7000	46.20	(101.85)		
800	1000	-	1455	500	600	1200	1500	1450	PSTX1050-600-70	1SFA898120R7000	64.20	(141.54)		
1000	1250	-	1810	600	700	1500	1800	1830	PSTX1250-600-70	1SFA898121R7000	64.70	(142.64)		

Rated operational voltage U_e , 208...690 V, Rated control supply voltage U_s , 100...250 V AC, 50/60 Hz

18.5	25	37	42	7.5	10	25	30	34	PSTX30-690-70	1SFA898203R7000	6.10	(13.45)
25	30	45	52	10	15	30	40	48	PSTX37-690-70	1SFA898204R7000	6.10	(13.45)
30	37	55	64	15	20	40	50	58	PSTX45-690-70	1SFA898205R7000	6.10	(13.45)
37	45	59	76	20	25	50	60	72	PSTX60-690-70	1SFA898206R7000	6.10	(13.45)
55	75	90	105	30	40	75	100	103	PSTX72-690-70	1SFA898207R7000	6.10	(13.45)
59	80	110	124	30	40	75	100	117	PSTX85-690-70	1SFA898208R7000	6.10	(13.45)
75	90	132	147	40	50	100	125	138	PSTX105-690-70	1SFA898209R7000	6.10	(13.45)
90	110	160	181	60	60	150	150	180	PSTX142-690-70	1SFA898210R7000	9.60	(21.16)
132	160	220	245	75	75	150	200	225	PSTX170-690-70	1SFA898211R7000	9.60	(21.16)
160	200	257	300	75	100	200	250	292	PSTX210-690-70	1SFA898212R7000	12.70	(27.99)
184	250	315	360	100	125	250	300	332	PSTX250-690-70	1SFA898213R7000	12.70	(27.99)
220	295	400	430	150	150	350	450	429	PSTX300-690-70	1SFA898214R7000	12.70	(27.99)
257	355	500	515	150	200	450	500	523	PSTX370-690-70	1SFA898215R7000	12.70	(27.99)
355	450	600	640	200	250	500	600	625	PSTX470-690-70	1SFA898216R7000	25.00	(55.12)
450	600	800	814	250	300	600	700	830	PSTX570-690-70	1SFA898217R7000	25.00	(55.12)
540	700	960	987	300	350	700	800	1020	PSTX720-690-70	1SFA898218R7000	46.20	(101.85)
710	880	1200	1247	400	500	1000	1200	1240	PSTX840-690-70	1SFA898219R7000	46.20	(101.85)
800	1000	1400	1455	500	600	1200	1500	1450	PSTX1050-690-70	1SFA898220R7000	64.20	(141.54)
1000	1250	1700	1810	600	700	1500	1800	1830	PSTX1250-690-70	1SFA898221R7000	64.70	(142.64)





PSTX - The advanced range

Accessories

For softstarter type		Wire range	Tightening torque max.	Type	Order code	Pkg qty	Weight (1 pce)			
		mm ²	Nm				kg	(lb)		
  LZ...	1SFT98099-095CZ SB8054CZ	Cable connectors for Cu cables								
		PSTX142 ... PSTX170	6-120	8	-	1SDA066917R1	3	0.113	(0.249)	
		PSTX142 ... PSTX170	2 x (50-95)	16	LZ185-2C/120	1SFN074709R1000	3	0.300	(0.661)	
		PSTX210 ... PSTX370	16-240	25	-	1SDA055016R1	3	0.133	(0.293)	
		PSTX210 ... PSTX370	2 x (70-185)	22	OZXB4	1SCA022194R0890	3	0.570	(1.257)	
		PSTX470 ... PSTX570	2 x (120-240)	35	-	1SDA013922R1	3	0.570	(1.257)	
		PSTX570 ... PSTX1050	3 x (70-185)	45	-	1SDA013956R1	3	0.570	(1.257)	
		Cable connectors for Al cables								
		PSTX142 ... PSTX170	95-185	31	-	1SDA054988R1	3	0.078	(0.172)	
		PSTX210 ... PSTX370	185-240	43	-	1SDA055020R1	3	0.133	(0.293)	
PSTX470 ... PSTX1050	2 x (120-240)	31	-	1SDA023380R0001	3	0.110	(0.243)			
<hr/>										
For softstarter type		Dimensions hole ø	bar mm	Type	Order code	Pkg qty	Weight (1 pce)			
		mm ²					kg	(lb)		
 LX...	1SFT98000-012C3	Terminal extensions								
		PSTX142 ... PSTX170	8.5	17.5 x 5	LX205	1SFN074810R1000	1	0.250	(5.551)	
		PSTX210 ... PSTX370	10.5	20 x 5	LX370	1SFN075410R1000	1	0.350	(0.772)	
		PSTX470 ... PSTX570	10.5	25 x 5	LX460	1SFN075710R1000	1	0.500	(1.102)	
		PSTX720 ... PSTX840	13	40 x 6	LX750	1SFN076110R1003	1	0.850	(1.874)	
 LW...	1SFT98000-011C3	Terminal enlargements								
		PSTX30 ... PSTX105	6.5	15 x 3	LW110	1SFN074307R1000	1	0.100	(0.220)	
		PSTX142 ... PSTX170	10.5	17.5 x 5	LW205	1SFN074807R1000	1	0.250	(5.551)	
		PSTX210 ... PSTX370	10.5	20 x 5	LW370	1SFN075407R1000	1	0.450	(0.992)	
		PSTX470 ... PSTX570	10.5	25 x 5	LW460	1SFN075707R1000	1	0.730	(1.609)	
		PSTX720 ... PSTX840	13	40 x 6	LW750	1SFN076107R1000	1	1.230	(2.712)	
<hr/>										
For softstarter type		Req. qty	Type	Order code	Pkg qty	Weight (1 pce)				
						kg	(lb)			
 PSLE460	1SFC132322F0002	Terminal nut washer								
		PSTX142 ... PSTX170	6	LL205-30	1SFN074811R1000	6	0.200	(0.441)		
		PSTX210 ... PSTX370	6	LL370-30	1SFN075411R1000	6	0.300	(0.661)		
		PSTX210 ... PSTX370	2	PSLE-300	1SFA899221R1003	2	0.300	(0.661)		
		PSTX470 ... PSTX570	6	PSLE460	1SFA899221R1004	6	0.600	(1.323)		
		PSTX720 ... PSTX840	6	PSLE750	1SFA899221R1005	6	0.750	(1.653)		
 LT ... -AC LT ... -C	1SFT98099-010C3	Terminal shrouds								
		PSTX142 ... PSTX170, short for use with cable clamps	2	LT205-30C	1SFN124801R1000	2	0,050	(0.110)		
		PSTX142 ... PSTX170, long for use with compression lugs	2	LT205-30L	1SFN124803R1000	2	0.220	(0.485)		
		PSTX210 ... PSTX370, short for use with cable clamps	2	LT370-30C	1SFN125401R1000	2	0.035	(0.077)		
		PSTX210 ... PSTX370, long for use with compression lugs	2	LT370-30L	1SFN125403R1000	2	0.280	(0.617)		
		PSTX210 ... PSTX370, long and deep for use with extending cable clamps, ATK300/2 and OZXB4	2	LT370-30D	1SFN125406R1000	2	0.150	(0.331)		
		PSTX470 ... PSTX570, short for use with cable clamps	2	LT460-AC	1SFN125701R1000	2	0.100	(0.220)		
		PSTX470 ... PSTX570, long for use with compression lugs	2	LT460-AL	1SFN125703R1000	2	0.800	(1.764)		
		PSTX720 ... PSTX840, short for use with cable clamps	2	LT750-AC	1SFN126101R1000	2	0.120	(0.265)		
		PSTX720 ... PSTX840, long for use with compression lugs	2	LT750-AL	1SFN126103R1000	2	0.825	(1.819)		
 LT ... -AL LT ... -L	1SFT98099-125	Terminal shrouds								
		PSTX142 ... PSTX170, short for use with cable clamps	2	LT205-30C	1SFN124801R1000	2	0,050	(0.110)		
		PSTX142 ... PSTX170, long for use with compression lugs	2	LT205-30L	1SFN124803R1000	2	0.220	(0.485)		
		PSTX210 ... PSTX370, short for use with cable clamps	2	LT370-30C	1SFN125401R1000	2	0.035	(0.077)		
PSTX210 ... PSTX370, long for use with compression lugs	2	LT370-30L	1SFN125403R1000	2	0.280	(0.617)				
PSTX210 ... PSTX370, long and deep for use with extending cable clamps, ATK300/2 and OZXB4	2	LT370-30D	1SFN125406R1000	2	0.150	(0.331)				
PSTX470 ... PSTX570, short for use with cable clamps	2	LT460-AC	1SFN125701R1000	2	0.100	(0.220)				
PSTX470 ... PSTX570, long for use with compression lugs	2	LT460-AL	1SFN125703R1000	2	0.800	(1.764)				
PSTX720 ... PSTX840, short for use with cable clamps	2	LT750-AC	1SFN126101R1000	2	0.120	(0.265)				
PSTX720 ... PSTX840, long for use with compression lugs	2	LT750-AL	1SFN126103R1000	2	0.825	(1.819)				

PSTX - The advanced range

Accessories

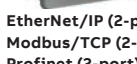
For softstarter type	Type	Order code	Pkg Weight qty (1 pce)		
			kg	(lb)	
 DeviceNet  Profibus Modbus-RTU  EtherNet/IP (1-port) Modbus/TCP (1-port)  EtherNet/IP (2-port) Modbus/TCP (2-port) Profinet (2-port)	Anybus connection accessory for communication protocol				
	Anybus suitable for PSTX30 ... PSTX1250				
	Profibus	AB-PROFIBUS-1	1SFA899300R1001	1	0.042 (0.093)
	DeviceNet	AB-DEVICENET-1	1SFA899300R1002	1	0.042 (0.093)
	Modbus-RTU	AB-MODBUS-RTU-1	1SFA899300R1003	1	0.042 (0.093)
	EtherNet/IP (1-port)	AB-ETHERNET-IP-1	1SFA899300R1005	1	0.042 (0.093)
	EtherNet/IP (2-port)	AB-ETHERNET-IP-2	1SFA899300R1006	1	0.042 (0.093)
	Modbus/TCP (1-port)	AB-MODBUS-TCP-1	1SFA899300R1007	1	0.042 (0.093)
	Modbus/TCP (2-port)	AB-MODBUS-TCP-2	1SFA899300R1008	1	0.042 (0.093)
	Profinet (2-port)	AB-PROFINET-2	1SFA899300R1010	1	0.042 (0.093)
 EtherNet/IP (1-port) Modbus/TCP (1-port)	FieldBusPlug connection accessory				
	PSTX30 ... PSTX1250	PS-FBPA	1SFA896312R1002	1	0.060 (0.132)
 EtherNet/IP (2-port) Modbus/TCP (2-port) Profinet (2-port)	ABB's FieldBusPlug suitable for all sizes, see latest softstarter catalog.				
	I/O module, 24 V DC digital input				
PSTX30 ... PSTX1250	DX111-FBP.0	1SAJ611000R0101	1	0.220 (0.485)	

PSTX - The advanced range

Technical data

Softstarter type		PSTX30 ... PSTX1250
Rated insulation voltage U_i		690V
Rated operational voltage U_e		208...600 V, 208...690V +10% / -15%, 50/60Hz ±10%
Rated control supply voltage U_s		100...250 V +10% / -15%, 50/60Hz ±10%
Rated control circuit voltage U_c		Internal or external 24 V DC
Starting capacity at I_e		4 x I _e for 10 sec.
Number of starts per hour		10 for PSTX30 ... PSTX370 ¹⁾ 6 for PSTX470 ... PSTX1250 ¹⁾
Overload capability	Overload class	10
Ambient temperature	During operation	-25...+60 °C, (-13...+140 F) ²⁾
	During storage	-40...+70 °C, (-40...+158 F)
Maximum altitude		4000 m (13123 ft) ³⁾
Degree of protection	Main circuit	-
	Supply and control circuit	IP20
Main circuit	Built-in bypass contactor	Yes
	Cooling system - Fan cooled	Yes (thermostat controlled)
HMI for settings	Display	LCD type, graphical
(Human Machine Interface)	Languages	Arabic, Chinese, Czech, Dutch, English, Finnish, French, German, Greek, Indonesian, Italian, Polish, Portuguese, Russian, Spanish, Swedish and Turkish
	Keypad	2 selection keys, 4 navigation keys, start key, stop key, info key and remote/local key
Signal relays	Number of programmable signal relays	3 (each relay can be programmed to None, Run, Top of ramp, Event group 0-6, Sequence 1-3 Run, Sequence 1-3 Top of ramp or Run reverse)
	K4	Default as Run signal
	K5	Default as Top of Ramp (Bypass) signal
	K6	Default as Event group 0 (Faults)
	Rated operational voltage, U _e	250 V AC/24 V DC
	Rated thermal current I _{th}	5 A
	Rated operational current I _e at AC-15 (U _e =250 V)	1.5 A
Analog output	Output signal reference	0...10 V, 0...10 mA, 0...20 mA, 4...20 mA
	Type of output signal	Motor current (A), Main voltage (V), Active power (kW), Active power (HP), Reactive power (kVar), Apparant power (kVarh), Active energy (kWh), Reactive energy (kVarh), cos phi, Motor temperature (%), Thyristor temperature (%), Motor voltage (%), Main frequency (Hz), PT100 temperature (centigrade), PTC resistance (Ohm)
Control circuit	Number of inputs	2 (start, stop)
	Number of additional programmable inputs	3 (each input can be programmed to: None, Reset, Enable, Slow speed forward (Jog), Slow speed reverse (Jog), Motor heating, Stand still brake, Start reverse, User defined protection, Emergency mode (active high), Emergency mode (active low), Fieldbus disable control, Start 1, Start 2, Start 3, Switch to remote control or Cancel brake)
Signalling indication LED	Ready	Green
	Run	Green
	Fault	Red
	Protection	Yellow
External keypad	Detachable keypad	Yes
	Display	LCD type, graphical
	Ambient temperature	
	During operation	-25...+60 °C, (-13...+140 F)
During storage	-40...+70 °C, (-40...+158 F)	
Degree of protection		IP66 (Type 1, 4X, 12)
Start and stop functions	Soft start with voltage ramp	Yes
	Soft stop with voltage ramp	Yes
	Soft start with torque control	Yes
	Soft stop with torque control	Yes
	Kick start	Yes
	Full voltage start	Yes
	Sequence start	Yes, 3 different sets of settings
	Current limit	Yes
	Dual current limit	Yes
	Current limit ramp	Yes
	Torque limit	Yes
	Pre-start function	Yes (Motor heating or Stand still brake)
	Jog with slow speed, forward and reverse	Yes (3 speed levels)
	Start reverse (external contactors)	Yes
	Dynamic brake	Yes
	Field bus connection	Built-in Modbus RTU
Connection for Anybus		Yes
Connection for ABB FieldBusPlug		Yes, with adapter

¹⁾ Valid for normal start (class 10) for 50% on time and 50% off time. If other data is required, contact your local ABB office.

²⁾ Above 40 °C (104 F) up to max. 60 °C (140 F) reduce the rated current with 0,8% per °C (0,44% per F).

³⁾ When used at high altitudes, above 1000 meters (3281 ft) up to 4000 meters (13123 ft), de-rate the rated current using the following formula.

[% of I_e = 100 - $\frac{x-1000}{1000}$] x = actual altitude of the softstarter in meter, [% of I_e = 100 - $\frac{x-3280}{3280}$] x = actual altitude of the softstarter in feet. For de-rating of voltage, contact your local ABB office.

PSTX - The advanced range

Technical data

Softstarter type		PSTX30 ... PSTX1250
Protections	Electronic overload protection, EOL	Yes (Class 10A, 10, 20, 30)
	Dual overload (separate overload for start and run)	Yes
	PTC connection	Yes
	PT-100 connection	Yes
	Locked rotor protection	Yes
	Current underload protection	Yes
	Current imbalance protection	Yes
	Power factor underload protection	Yes
	Under voltage protection	Yes
	Over voltage protection	Yes
	Voltage imbalance protection	Yes
	Earth fault protection / ground fault protection	Yes
	Phase reversal protection	Yes
	24 V output protection	Yes
	Frequency range protection	Yes
	Bypass open protection	Yes
	User defined protection	Yes
	Too long current limit protection	Yes
	HMI failure protection	Yes
	Fieldbus failure protection	Yes
	Extension IO failure protection	Yes
	Max number of starts/hour	Yes
	Too long start time protection	Yes
Warnings	Current underload warning	Yes
	Current imbalance warning	Yes
	Voltage imbalance warning	Yes
	Thyristor overload warning (SCR)	Yes
	Electronic overload Time-to-trip	Yes
	Short circuit warning (for Limp mode)	Yes
	Over voltage warning	Yes
	Under voltage warning	Yes
	Power factor underload warning	Yes
	Locked rotor warning	Yes
	Faulty fan warning	Yes
	THD(U) - Total Harmonic Distortion warning	Yes
	Motor runtime limit warning	Yes
	Phase loss warning (for stand by)	Yes
	EOL warning	Yes
External faults detection	Phase loss	Yes
	High current	Yes
	Low control supply voltage	Yes
	Faulty usage (e.g. using limp mode inside-delta)	Yes
	Faulty connection	Yes
Internal faults detection	Bad network quality	Yes
	Thyristor overload	Yes
	Short circuit	Yes
	Open circuit thyristor or gate	Yes
	Heat sink over temperature	Yes
PTC input	Shunt fault	Yes
	Switch off resistance	2825 ohm \pm 20%
	Switch on resistance	1200 ohm \pm 20%
Other functions	Real time clock	Yes
	Event log	Yes
	Emergency mode	Yes
	Automatic restart	Yes
	Secure settings	Yes
	Keypad password	Yes
	Electronic overload Time-to-cool	Yes
	Thyristor runtime measurement	Yes
	Auto phase sequence detection	Yes
	Electricity metering	Yes
	Motor heating	Yes
	Stand still brake	Yes
	Voltage sags detection	Yes
	Limp mode with two-phase motor control if one set of thyristors is shorted	Yes

PSTX - The advanced range

Technical data

Fuse ratings and power losses

For softstarter	Current range	Max power loss at rated I_e	Max fuse rating - main circuit ^{1) 2)} Bussmann fuses, DIN43 620 (Knife)			Power requirements supply circuit Holding (VA) / Pull-in (VA)
			A	Type	Size	
Type	A	W	A	Type	Size	
PSTX30	9.0...30.0	0.8	100	170M1567	000	49/51
PSTX37	11.1...37.0	1.2	125	170M1568	000	49/51
PSTX45	13.5...45.0	1.8	160	170M1569	000	49/51
PSTX60	18.0...60.0	3.2	160	170M1569	000	49/51
PSTX72	21.6...72.0	4.7	250	170M1571	000	49/51
PSTX85	22.5...85.0	6.5	315	170M1572	000	49/51
PSTX105	31.8...106.0	10	400	170M3819	1*	49/51
PSTX142	42.9...143.0	18	500	170M5810	2	49/53
PSTX170	51.3...171.0	26	630	170M5812	2	49/53
PSTX210	63.0...210.0	48	630	170M5812	2	56/276
PSTX250	75.0...250.0	68	700	170M5813	2	56/276
PSTX300	90.0...300.0	97	800	170M6812	3	56/276
PSTX370	111.0...370.0	148	900	170M6813	3	56/276
PSTX470	141.0...470.0	99	900	170M6813	3	67/434
PSTX570	171.0...570.0	146	1000	170M6814	3	67/434
PSTX720	216.0...720.0	78	1250	170M8554	3	61/929
PSTX840	252.0...840.0	106	1500	170M6018	3	61/929
PSTX1050 ³⁾	315.0...1050.0	165	1800	170M6020	3	68/929
PSTX1250 ^{3) 4)}	375.0...1250.0	234	2000	170M6021	3	68/929

¹⁾ For the supply circuit 6 A delayed, for MCB use C characteristics.

²⁾ For inside delta connection the fuses shall be placed inside the delta. Contact ABB for more information.

³⁾ 170M6019 with fuse rating 1600 A should be used for 690 V version.

⁴⁾ For 690 V version, Bussmann fuses are only available for motors with rated current up to 1150 A.

PSTX Integrated bypass ratings

Softstarter	PSTX470	PSTX570	PSTX720	PSTX840	PSTX1050	PSTX1250
Integrated contactor	AF370			AF750		AF1250
AC-3 rating at 400 V (A)	370			750		-
IEC AC-3 Rated operational power at 400 V (kW)	200			400		-
UL/CSA 3-phase motor rating at 480 V (hp)	300			600		-



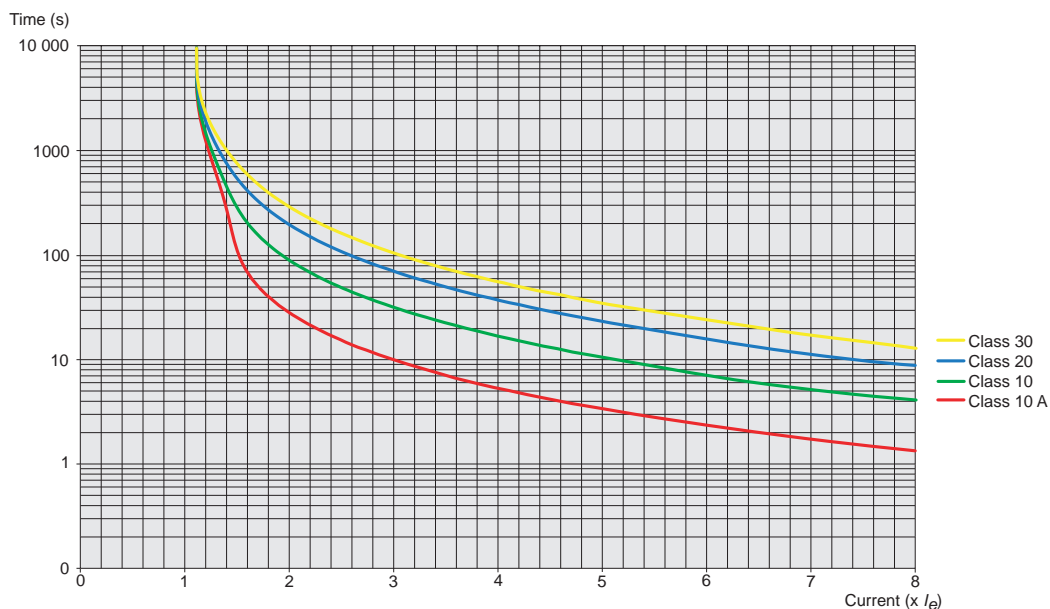





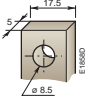

Tripping curves for the integrated electronic overload protection. All units have an integrated electronic overload protection that can be set to four different tripping classes. Below you find a curve for each tripping class in cold state. These tripping curves are valid for PSTX.

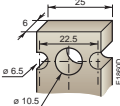
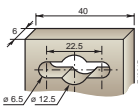
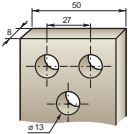

Tripping curves for electronic overload protection (cold) for PSE and PSTX.

PSTX - The advanced range

Technical data

Main terminals		PSTX30 ... PSTX105	PSTX142 ... PSTX170	PSTX210 ... PSTX370	PSTX470 ... PSTX570	PSTX720 ... PSTX1050	PSTX1250
							
	Cu cable - flexible	1 x mm ²	10...70 mm ²	6...120 mm ²	16...240 mm ²	-	-
	Clamp type	Included	1SDA066917R1	1SDA055016R1	-	-	-
	Tightening torque	8 Nm	14 Nm	25 Nm	-	-	-
	Cu cable - flexible	2 x mm ²	6...35 mm ²	50...95 mm ²	70...185 mm ²	-	-
	Clamp type	Included	LZ185-2C/120	OZXB4 ¹⁾	-	-	-
	Tightening torque	8 Nm	16 Nm	22 Nm	-	-	-
	Cu cable - Stranded	1 x mm ²	10...95 mm ²	6...150 mm ²	16...300 mm ²	-	-
	Clamp type	Included	1SDA066917R1	1SDA055016R1	-	-	-
	Tightening torque	8 Nm	14 Nm	25 Nm	-	-	-
	Cu cable - Stranded	2 x mm ²	6...35 mm ²	50...120 mm ²	70...185 mm ²	120...240 mm ²	-
	Clamp type	Included	LZ185-2C/120	OZXB4 ¹⁾	1SDA013922R1	-	-
	Tightening torque	8 Nm	16 Nm	22 Nm	35 Nm	-	-
	Cu cable - Stranded	3 x mm ²	-	-	-	70...185 mm ²	-
	Clamp type	-	-	-	-	1SDA013956R1	-
	Tightening torque	-	-	-	-	45 Nm	-
	Al cable - Stranded	1 x mm ²	-	95...185 mm ²	185...240 mm ²	-	-
	Clamp type	-	-	1SDA0549881R1	1SDA055020R1	-	-
	Tightening torque	-	-	31 Nm	43 Nm	-	-
	Al cable - Stranded	2 x mm ²	-	-	-	120...240 mm ²	-
	Clamp type	-	-	-	-	1SDA023380R1	-
	Tightening torque	-	-	-	-	31 Nm	-
	Lugs	Width ≤	-	24 mm (0.945 in)	32 mm (1.260 in)	47 mm (1.850 in)	50 mm (1.969 in)
		Diameter ≥	-	8 mm (0.355 in)	10.2 mm (0.402 in)	10.5 mm (0.413 in)	12.5 mm (0.492 in)
		Tightening torque	-	18 Nm (160 in lb)	28 Nm (248 in lb)	35 Nm (310 in lb)	45 Nm (398 in lb)
Connection capacity acc to UL / CSA 1 x AWG / kcmil		6...2/0	6...300 kcmil	4...400 kcmil	-	-	-
	Clamp type	Included	ATK185	ATK300	-	-	-
	Tightening torque	71 in lb	300 in lb	375 in lb	-	-	-
Connection capacity acc to UL / CSA 2 x AWG / kcmil		-	-	4...500 kcmil	2/0...500 kcmil	2/0...500 kcmil	-
	Clamp type	-	-	ATK300/2 ²⁾	ATK580/2	ATK580/2	-
	Tightening torque	-	-	375 in lb	375 in lb	375 in lb	-
Connection capacity acc to UL / CSA 3 x AWG / kcmil		-	-	-	2/0...500 kcmil	2/0...500 kcmil	-
	Clamp type	-	-	-	ATK750/3	ATK750/3	-
	Tightening torque	-	-	-	375 in lb	375 in lb	-
Supply and control circuit							
	Cu cable - Stranded 1 x mm ²				0.75...2.5 mm ² (19...14 AWG)		
	Cu cable - Stranded 2 x mm ²				0.75...1.5 mm ² (19...16 AWG)		
	Tightening torque				0.5 Nm (4.4 in lb)		

¹⁾ Terminal shrouds 1SFN125406R1000 must be used.

²⁾ Terminal shrouds 1SFN125406R1000 can be used.

PSTX - The advanced range

Dimensions

Main dimensions mm, inches

PSTX30 ... PSTX105

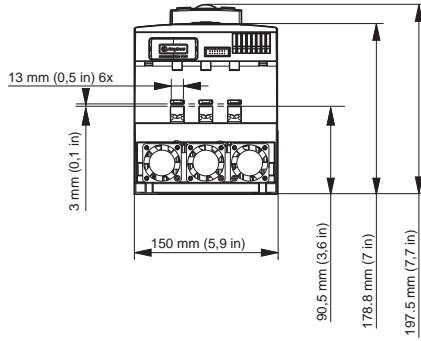

PSTX142 ... PSTX170

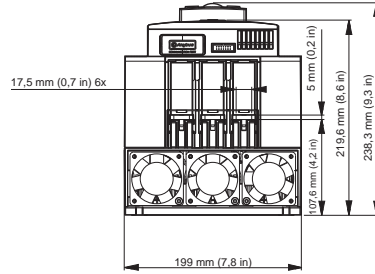

PSTX210 ... PSTX370

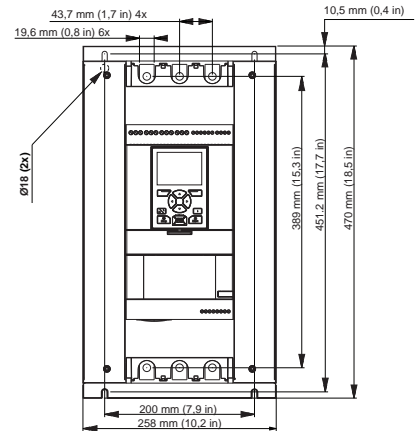
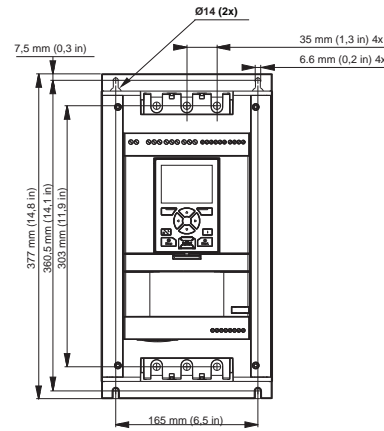
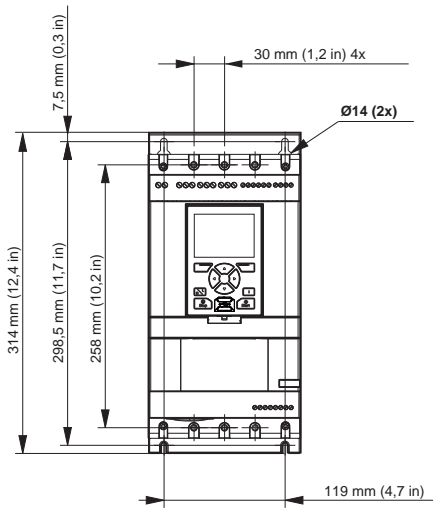
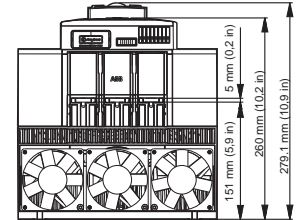

PSTX detachable keypad

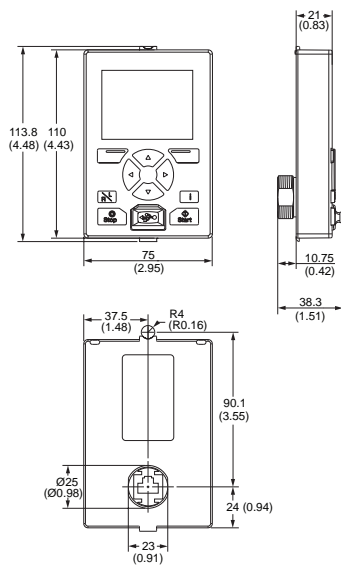

PSTX - The advanced range

Dimensions

Main dimensions mm, inches

PSTX470 ... PSTX570

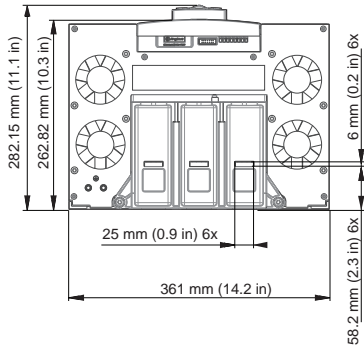

PSTX720 ... PSTX840

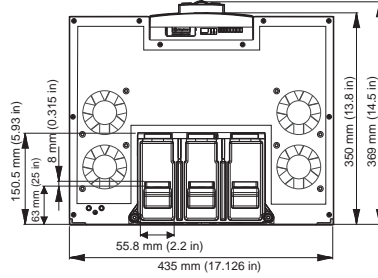

PSTX1050

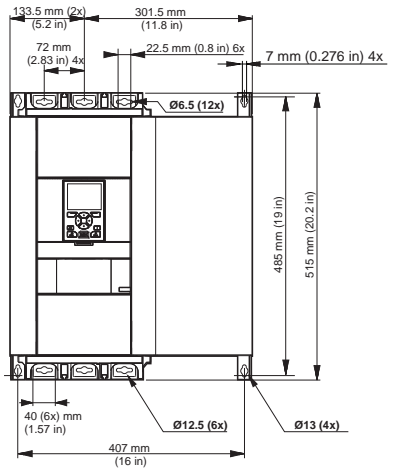
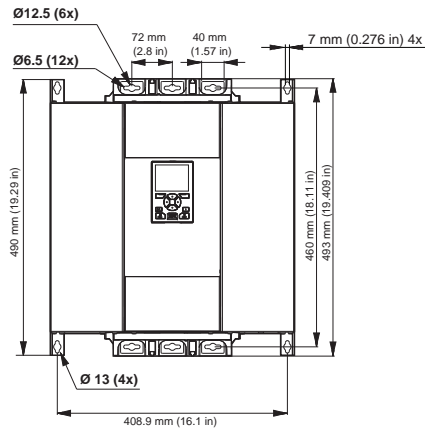
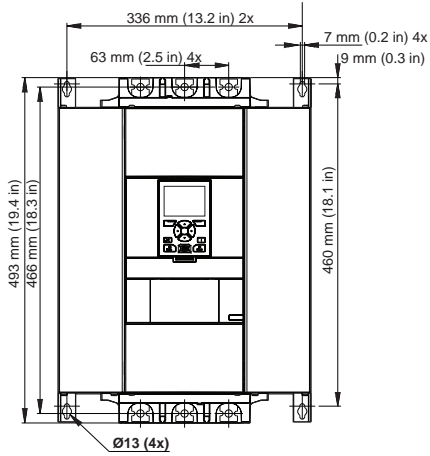
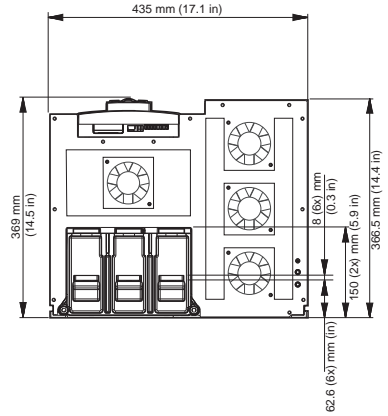

PSTX1250

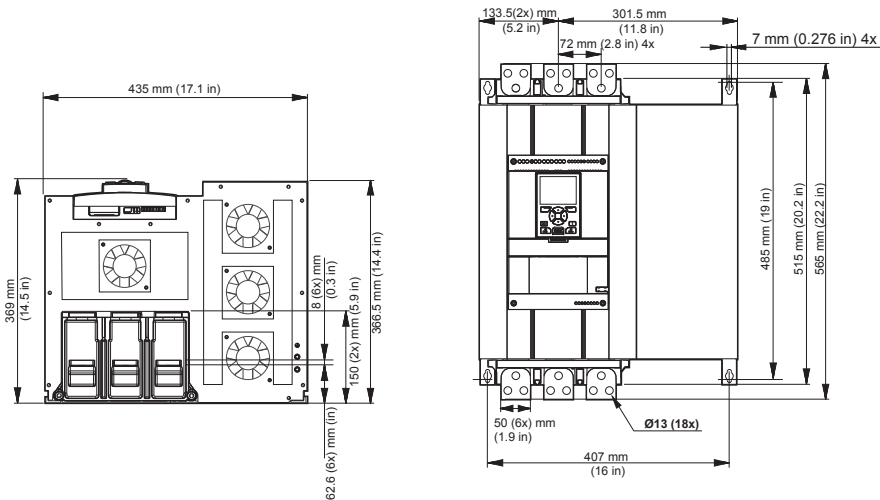

PSTX - The advanced range

Circuit diagrams



CAUTION

Terminal 22 is a function earth, it is not a protective earth. It shall be connected to the mounting plate.

PSTX30 ... PSTX1250

IEC circuit diagram

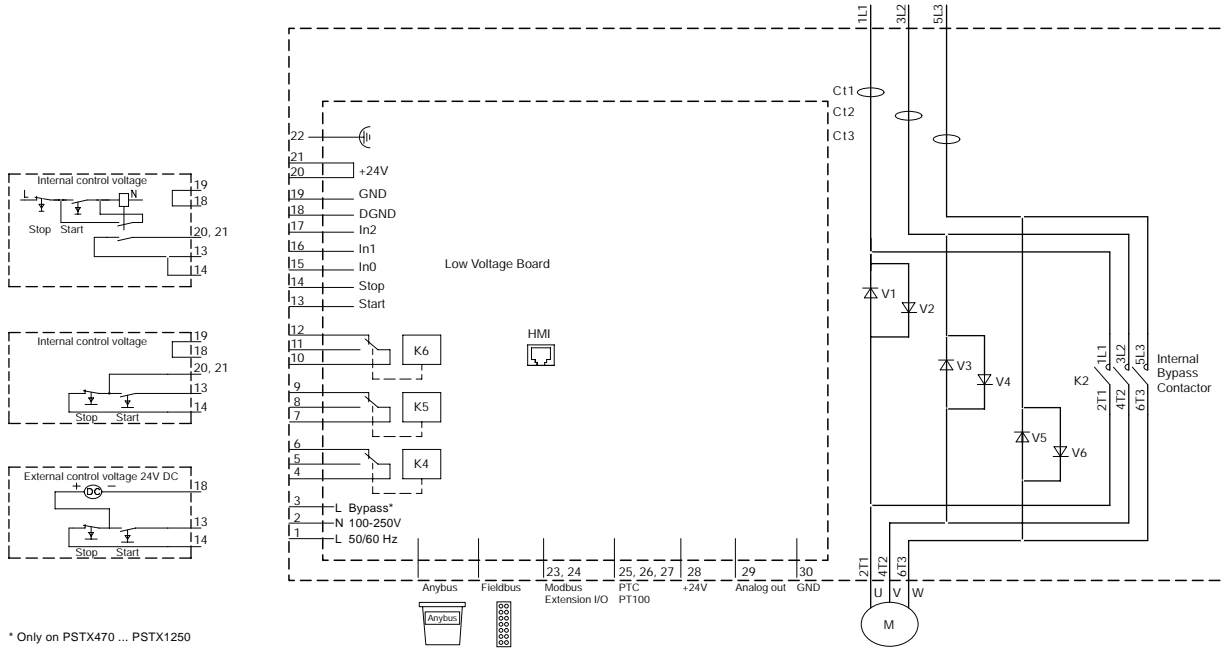

* Only on PSTX470 ... PSTX1250

UL circuit diagram

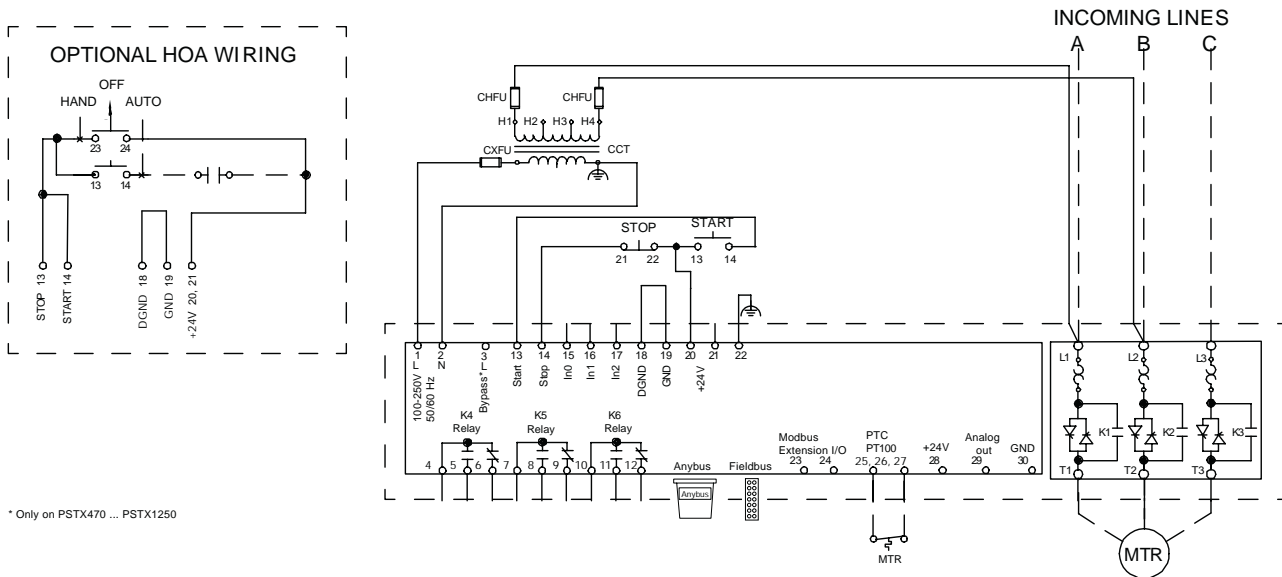

* Only on PSTX470 ... PSTX1250

PSTX - The advanced range

Circuit diagrams

PSTX30 ... PSTX1250

In-line connected with line contactor and fuses

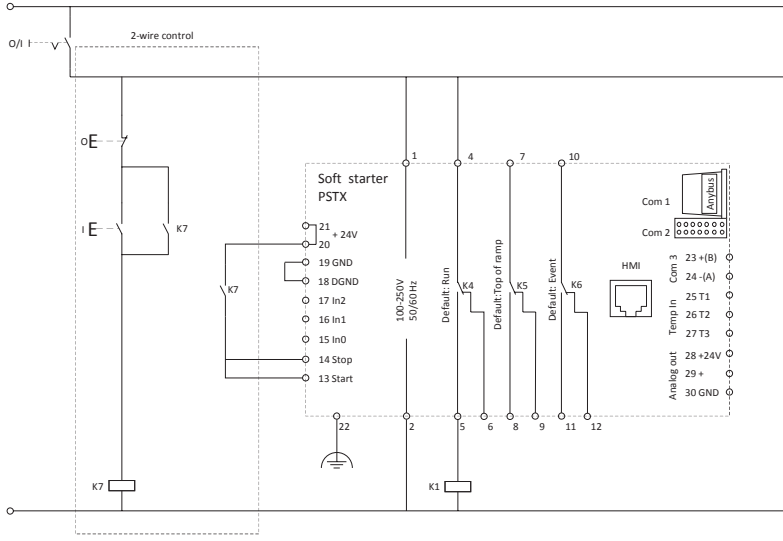

Coil consumption for main contactors.
 Pull-in max 15A
 Holding max 1.5A

If the pull-in or holding values are higher, the main contactors must be controlled via an auxiliary contactor.

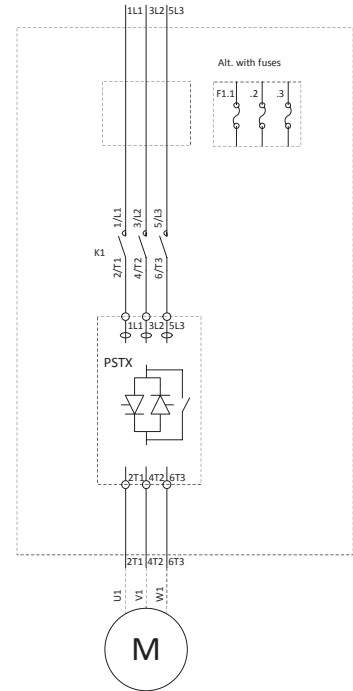
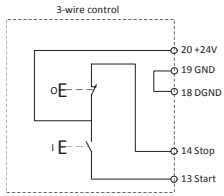

Inside-delta connected with contactor and fuses

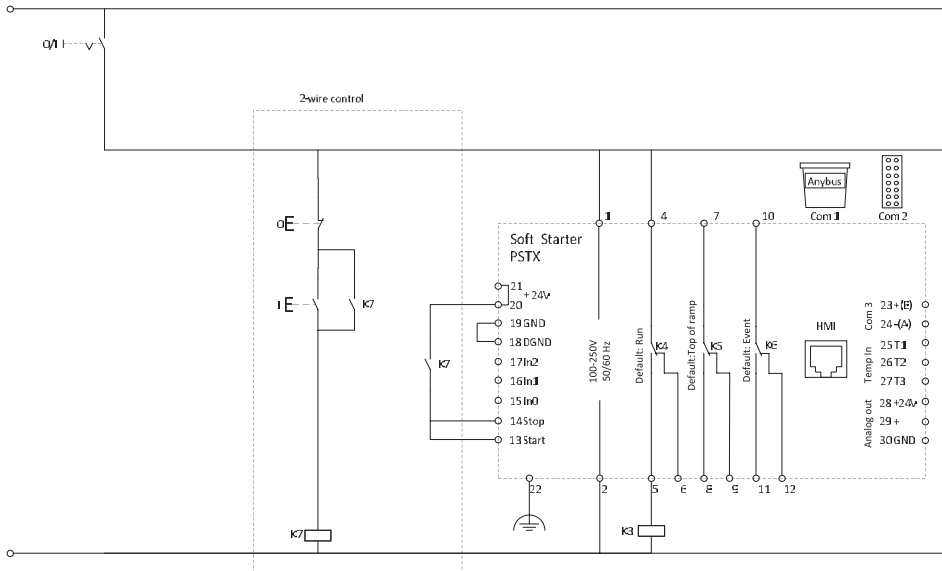

Coil consumption for Inside Delta contactor.
 Pull-in max 15A
 Holding max 1,5A

If the pull-in or holding values are higher, the Inside Delta contactor must be controlled via an auxiliary contactor.

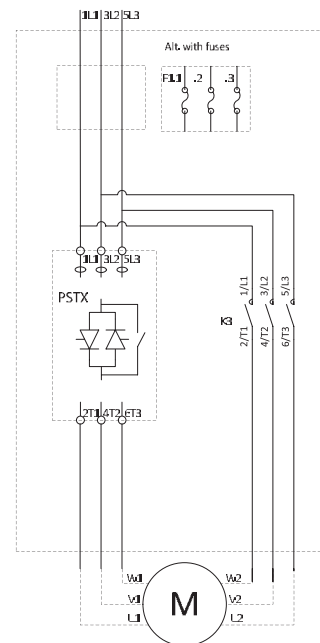
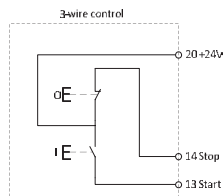



Fieldbus communication

60	Introduction
61	Anybus ordering details
63–63	Fieldbusplug ordering details
64–65	Fieldbusplug accessories ordering details

Fieldbus communication



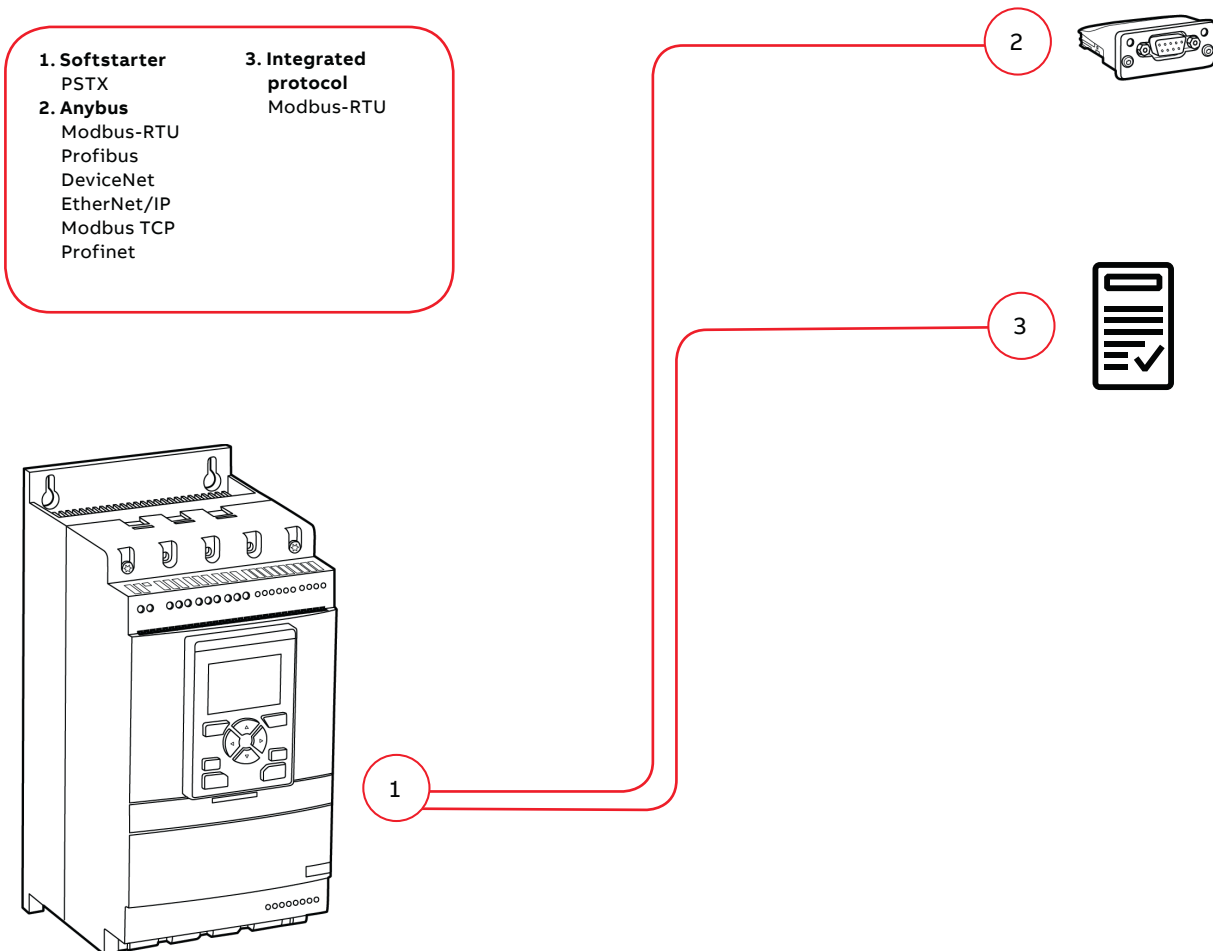

Introduction

PSR, PSE and PSTX softstarters can be connected to a fieldbus network for monitoring and control. All major industrial fieldbus protocols are covered with different accessories making the installation very flexible.



Fieldbus communication

Anybus ordering details

	For communication protocol	Type	Order code	Pkg qty	Weight (1 pce) kg	(lb)
 Profibus Modbus-RTU	Profibus	AB-PROFIBUS-1	1SFA899300R1001	1	0.042	(0.093)
	DeviceNet	AB-DEVICENET-1	1SFA899300R1002	1	0.042	(0.093)
 EtherNet/IP (1-port) Modbus TCP (1-port)	Modbus-RTU	AB-MODBUS-RTU-1	1SFA899300R1003	1	0.042	(0.093)
	EtherNet/IP (1-port)	AB-ETHERNET-IP-1	1SFA899300R1005	1	0.042	(0.093)
	EtherNet/IP (2-port)	AB-ETHERNET-IP-2	1SFA899300R1006	1	0.042	(0.093)
	Modbus TCP (1-port)	AB-MODBUS-TCP-1	1SFA899300R1007	1	0.042	(0.093)
	Modbus TCP (2-port)	AB-MODBUS-TCP-2	1SFA899300R1008	1	0.042	(0.093)
	Profinet (2-port)	AB-PROFINET-IO-2	1SFA899300R1010	1	0.042	(0.093)
 DeviceNet						
 EtherNet/IP (2-port) Modbus TCP (2-port) Profinet (2-port)						